



2021

**Guidance of Heat Transfer
Analysis for Ships Carrying
Liquefied Gases in Bulk/Ships
Using Liquefied Gases as Fuels**



2021

**Guidance of Heat Transfer
Analysis for Ships Carrying
Liquefied Gases in Bulk/Ships
Using Liquefied Gases as Fuels**

APPLICATION OF “GUIDANCE OF HEAT TRANSFER ANALYSIS FOR SHIPS CARRYING LIQUEFIED GASES IN BULK/SHIPS USING LIQUEFIED GASES AS FUELS”

1. Unless expressly specified otherwise, the requirements in the Guidance apply to ships for which contracts for construction are signed on or after 1 July 2021.
2. The amendments to the Guidance for 2020 edition and their effective date are as follows;

Effective Date 1 July 2021

CHAPTER 1 GENERAL

Section 1 Application

- 101. 1 has been amended.

CHAPTER 2 HEAT TRANSFER ANALYSIS FOR MEMBRANE TYPE

Section 1 Analytical Heat Transfer Analysis

- Organization has been amended.

Section 2 FEM Heat Transfer Analysis

- Organization has been amended.
- 204. 2 (2) has been newly added.

CHAPTER 3 HEAT TRANSFER ANALYSIS FOR INDEPENDENT TYPE A TANK

Section 1 Analytical Heat Transfer Analysis

- newly added.

Section 2 FEM Heat Transfer Analysis

- newly added.

CHAPTER 4 HEAT TRANSFER ANALYSIS FOR INDEPENDENT TYPE B TANK

Section 1 Analytical Heat Transfer Analysis

- newly added.

Section 2 FEM Heat Transfer Analysis

- newly added.

CHAPTER 5 HEAT TRANSFER ANALYSIS FOR INDEPENDENT TYPE C TANK

Section 1 Analytical Heat Transfer Analysis

- newly added.

Section 2 FEM Heat Transfer Analysis

- newly added.

CONTENTS

CHAPTER 1 GENERAL	1
Section 1 Application	1
Section 2 Definitions	1
Section 3 Summary of Guidances	2
Section 4 Documentation	4
CHAPTER 2 HEAT TRANSFER ANALYSIS FOR MEMBRANE TYPE	5
Section 1 Analytical Heat Transfer Analysis	5
Section 2 FEM HEAT TRANSFER ANALYSIS	21
CHAPTER 3 HEAT TRANSFER ANALYSIS FOR INDEPENDENT TYPE A TANK ...	25
Section 1 Analytical Heat Transfer Analysis	25
Section 2 FEM HEAT TRANSFER ANALYSIS	26
CHAPTER 4 HEAT TRANSFER ANALYSIS FOR INDEPENDENT TYPE B TANK ...	27
Section 1 Analytical Heat Transfer Analysis	27
Section 2 FEM HEAT TRANSFER ANALYSIS	28
CHAPTER 5 HEAT TRANSFER ANALYSIS FOR INDEPENDENT TYPE C TANK ...	31
Section 1 Analytical Heat Transfer Analysis	31
Section 2 FEM HEAT TRANSFER ANALYSIS	31

CHAPTER 1 GENERAL

Section 1 Application

101. Application

1. This guidance applies to the assessment procedure of heat transfer analysis on the hull of ships carrying liquefied gases in bulk and the hull of ships using liquefied gases as fuels.
2. This guidance deals with the selection of steel grade and welding consumables on ships carrying liquefied gases in bulk and ships using liquefied gases as fuels.
3. Requirement of this guidance shall apply in addition to the other requirement of Rules for the Classification of Steel Ships.

102. Equivalence

In the case that the application of this guidance is not appropriate or that the Society allow that the special method and the procedure not specified in this guidance is at least equivalent to those in effect for the provision of this guidance, it is assumed to be appropriate for the provision of this guidance. In this case in order to verify that the heat transfer analysis is at least equivalent to the standard of this guidance, the related information should be submitted to the Society and the evaluation method is to be consulted with the Society. From the initial design phase, the purpose to use the different method should be sufficiently discussed.

Section 2 Definitions

201. Application

The definitions of terms, except otherwise specified, are to be in accordance with Rules for the Classification of Steel Ships.

202. Overall heat transfer coefficient

Overall heat transfer coefficient means the heat transfer coefficient by considering all heat transfer methods including convection, radiation and conduction.

203. Prandtl number

Prandtl number represent the relative thickness of the velocity and the thermal boundary layer and is defined as the ratio of momentum diffusivity to thermal diffusivity.

204. Nusselt number

Nusslet number(Nu) means the ratio of convective to conductive heat transfer across the boundary.

205. Rayleigh number

The Rayleigh number is defined as the product of the Grashof number and the Prandtl number. It indicates whether heat transfer occurs as conduction or convection.

206. Reynolds number

Reynolds number means the ratio of the inertia forces to viscous forces in the fluid.

207. Grashof number

Grashof number means the ratio of buoyancy to viscous force acting on a fluid.

Section 3 Summary of Guidances

301. General

1. The cargo tank of the ships carrying liquefied gases in bulk or the fuel tank of ships using liquefied gases as fuels is likely to make the hull structure cold due to the low temperature of the liquefied gas. In general, steels increase brittleness at low temperature, so brittle fracture of ships carrying liquefied gases in bulk/ships using liquefied gases as fuels through proper steel selection should be avoided. For this purpose, the IGC Code requires that the heat transfer analysis of ships carrying liquefied gases in bulk be carried out and the steel of the hull structure be selected based on the analysis.

302. Methods of heat transfer analysis

1. General

- (1) This guidance applies two heat transfer analysis methods. The first is the analytical heat transfer analysis method and the second is the finite element heat transfer analysis method.
- (2) The flowchart of the heat transfer analysis method presented in this guidance is shown in **Fig 1.1**.
- (3) The user should decide which method to use between the two heat transfer analysis methods.

2. Analytical Heat Transfer Analysis

- (1) The analytical heat transfer analysis method is a method of solving the basic thermal equilibrium equation to obtain the temperature, which is easily applicable and can predict the temperature value. The calculated temperature means the average temperature of each section. Based on this, the steel grade is selected and finally the welding consumable is also selected.
- (2) Air temperature, sea water temperature and wind speed are selected based on the navigation area of the ship for program input. Air temperature, sea water temperature and wind speed in IMO IGC Code or USCG may be used. The material properties for heat transfer analysis should be defined and the properties of steel, insulation, seawater and air should be selected in consideration of temperature. After all input for analytical heat transfer analysis is prepared, the analysis is performed. The steel grade is selected based on the temperature of each part obtained as a result of the analysis. Also, the welding consumable is selected based on the selected steel grade.

3. FEM Heat Transfer Analysis

- (1) Finite element heat transfer analysis method can estimate hull temperature distribution by considering complex hull structure. Since each section of the hull is divided into several elements to perform the analysis, it is calculated to have a temperature distribution along one structural member. The average temperature of the structural member is calculated and steel grade and welding consumable are selected based on this.
- (2) If finite element heat transfer analysis method is selected, general finite element analysis software can be used. Two-dimensional analysis modeling or three-dimensional analysis modeling work should be performed considering the hull structure to be analyzed. Air temperature, seawater temperature and wind speed should be selected based on the navigation area of the ship for program input. In this case, IMO IGC Code or USCG can be used.
- (3) The material properties for the heat transfer analysis must be entered into the software.
- (4) The steel grade is selected based on the temperature of each part obtained as a result of the analysis. At this time, the steel grade is selected using the average temperature of the members. Welding consumable is selected based on the steel grade determined using the average temperature of the member.

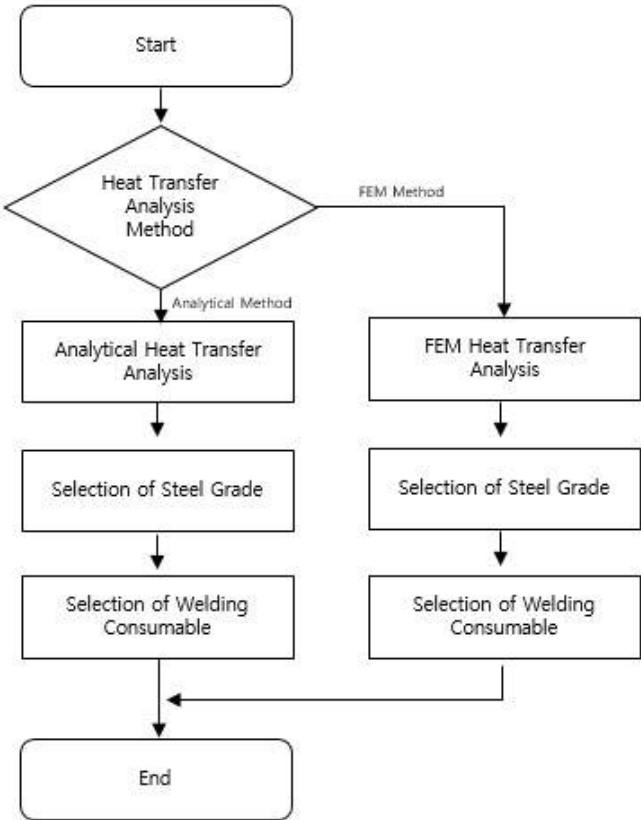

Fig 1.1 Flowchart of heat transfer analysis

Section 4 Documentation

401. Resource for approval

1. Depending on the assessment method of the heat transfer analysis on ships carrying liquefied gases in bulk/ships using liquefied gases as fuels, the following materials should be submitted to the Society and to be approved by the Society. In addition, if deemed necessary, the Society may require the submission of data other than those specified below.
 - (1) By analytical heat transfer analysis method
 - (A) General information of analysis including model of heat transfer analysis, heat transfer analysis design condition and boundary condition
 - (B) The result of heat transfer analysis
 - (C) The result of steel grade selection
 - (D) Material properties and their basis
 - (E) In case of ships carrying liquefied gases in bulk, the drawing of cargo containment system and the related supports
 - (a) The data for type of cargo containment system
 - (b) The detail drawing of representative basic model
 - (F) In case of ships using liquefied gases as fuels, the drawing of fuel tank and the related supports
 - (a) The data for type of fuel tank
 - (b) The detail drawing of representative basic model
 - (2) By FEM heat transfer analysis method
 - (A) General information of analysis including model of heat transfer analysis, heat transfer analysis design condition and boundary condition
 - (B) The result of heat transfer analysis
 - (C) The result of steel grade selection
 - (D) If necessary, the result of welding consumables selection
 - (E) Material properties and their basis
 - (F) In case of ships carrying liquefied gases in bulk, the drawing of cargo containment system and the related supports
 - (a) The data for type of cargo containment system
 - (b) The detail drawing of representative basic model
 - (G) In case of ships using liquefied gases as fuels, the drawing of fuel tank and the related supports
 - (a) The data for type of fuel tank
 - (b) The detail drawing of representative basic model

402. The reference data

1. In the case of ships carrying liquefied gases in bulk
 - (1) The main source of the ship
 - (2) Restrictions on cargo operations, such as limiting the height of the cargo loading, cooling down speed.
 - (3) The layout of cargo containment system in each cargo hold
 - (4) The general arrangement of ship with the cargo containment system installed
 - (5) The design constraints of the cargo containment system
2. In the case of ships using liquefied gases as fuels
 - (1) The main source of the ship
 - (2) Restrictions on cargo operations, such as limiting the height of the cargo loading, cooling down speed.
 - (3) The layout of fuel tank
 - (4) The design constraints of fuel tank ↴

CHAPTER 2 HEAT TRANSFER ANALYSIS FOR MEMBRANE TYPE

Section 1 Analytical Heat Transfer Analysis

101. Analysis Procedure

1. Procedure of analytical heat transfer analysis

- (1) The analytical heat transfer analysis is performed according to the flowchart in **Figure 2.1**.
 - (A) As shown in **Figure 2.2**, the work to divide the compartment for analytical two-dimensional heat transfer analysis into sections is performed.
 - (B) Defines the boundary conditions for the compartment. This includes the settings of the length, width and area of all members of the compartment, seawater temperature, air temperature, wind speed and emissivity of the steel.
 - (C) Assume initial temperature of compartment and member.
 - (D) Calculate the overall heat transfer coefficient.
 - (E) Calculate the temperature of compartment and member.
 - (F) If the change in temperature is below the reference value, the calculation is stopped; otherwise, the calculation is performed in step (D).
 - (G) Perform the above operation to the last compartment to be analyzed.
 - (H) Obtain the hull temperature calculation results.
- (2) Analytical heat transfer analysis method is performed through iterative procedures. In order to reduce the number of repetitions, the initial temperature is set to the atmospheric temperature or the seawater temperature according to the surrounding environment to be contacted.

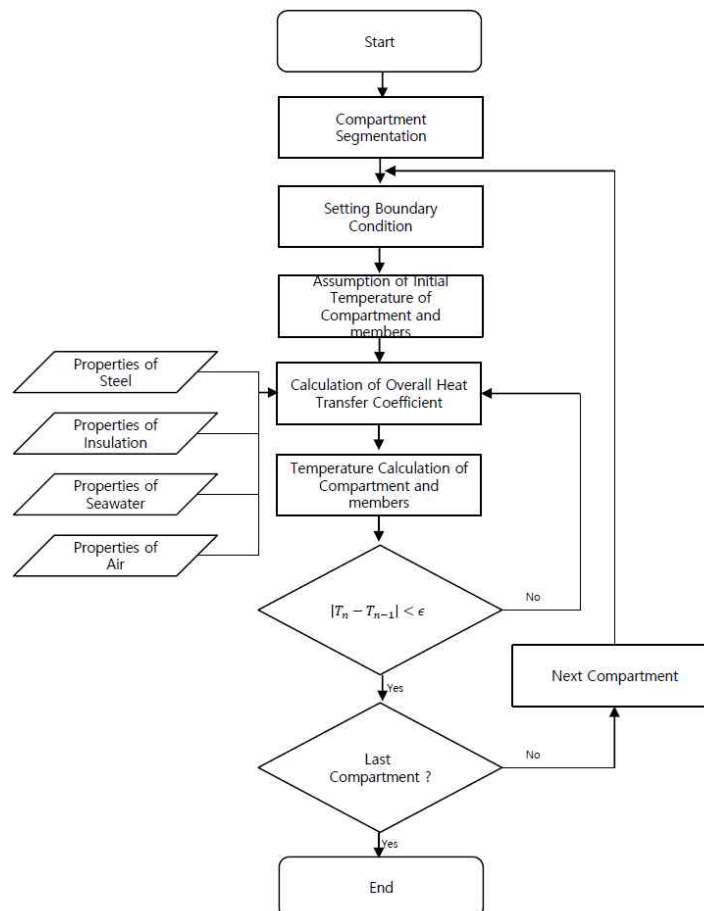

Fig 2.1 Iterative procedure flowchart of analytical heat transfer analysis

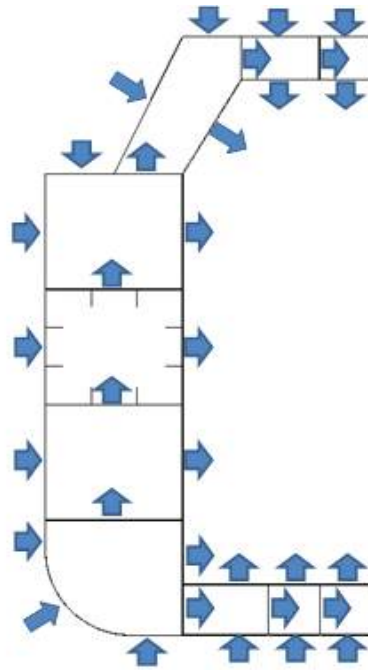

Fig 2.2 Segmentation for heat transfer analysis of ships carrying liquefied gases in bulk

102. Modeling

1. 1-Dimensional heat transfer analysis model

- (1) The one-dimensional heat transfer analysis model provides the information necessary to understand the analytical heat transfer analysis method and the two-dimensional model is an extension of the one-dimensional model. The one-dimensional heat transfer analysis model is considered as a horizontal and vertical model and an example is shown in **Figure 2.3**.

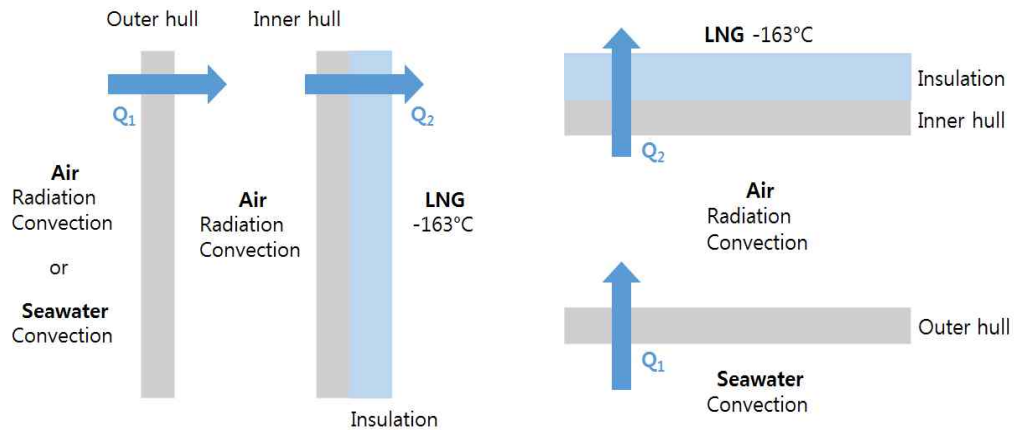

Fig 2.3 Example of one-dimensional horizontal and vertical heat transfer analysis model

- (2) The equilibrium equation of the one-dimensional heat transfer analysis is defined as follows.

$$\sum Q = 0$$

$$\sum Q = Q_1 + Q_2 = 0$$

- (3) The heat transfer of the one-dimensional heat transfer model is defined as follows using the overall heat transfer coefficient.

$$Q_n = U_n \cdot A_n \cdot (T_1 - T_2)$$

U : Overall heat transfer coefficient

A : Area of Heat Transfer

- (4) The overall heat transfer coefficient is obtained by a combination of heat transfer coefficient of convection, conduction and radiation, and the above case is defined as follows.

- (A) Overall heat transfer coefficient for Q_1

$$1/U_1 = 1/(h_{C,EN/OH} + h_{R,EN/OH}) + t_{OH}/k_{OH} + 1/(h_{C,OH/CO} + h_{R,OH/CO})$$

- (B) Overall heat transfer coefficient for Q_2

$$1/U_2 = 1/(h_{C,CO/IH} + h_{R,CO/IH}) + t_{IH}/k_{IH} + t_{INS}/k_{INS} + 1/(h_{C,INS/LNG} + h_{R,INS/LNG})$$

EN : Environment

OH : Outer hull

IH : Inner hull

INS : Insulation

CO : Compartment

h_C : Convection heat transfer coefficient

h_R : Radiation heat transfer coefficient

t : Thickness

k : Thermal conductivity

(C) Heat transfer coefficient(h_C) of convection is calculated as follows.

$$h_{conv} = \frac{N_u \cdot k}{L}$$

N_u : Nusselt number

k : Fluid thermal conductivity

L : Characteristic length

(D) Heat transfer coefficient(h_R) of radiation is calculated as follows.

$$h_{rad} = \varepsilon \sigma (T_1^2 + T_2^2)(T_1 + T_2)$$

σ : Stefan-Boltzmann Constant($5.6703 \times 10^{-8} W/m^2 K^4$)

ε : Emissivity

(5) The temperature of the compartment and members is obtained in the same way as the method for obtaining the steel temperature in the example of **Fig 2.4**.

(A) The heat flux through the outer hull is expressed as follows.

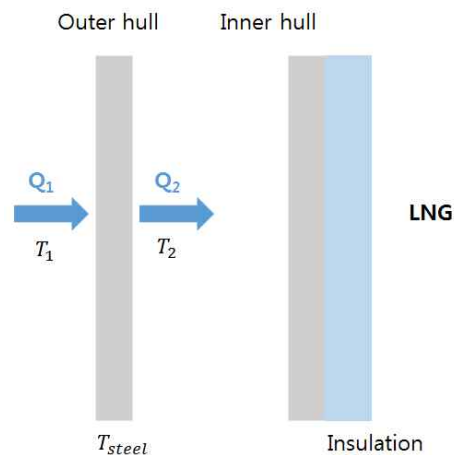

Fig 2.4 Scheme of heat flux flow from outside to inside of LNG cargo tank

$$Q_1 = U_1 A (T_1 - T_{steel}), \quad Q_2 = U_2 A (T_{steel} - T_2)$$

U_1, U_2 : Overall heat transfer coefficient

T_1 : The temperature of the atmosphere/seawater

T_2 : The temperature of the compartment

A : Area of Heat Transfer

(B) In equilibrium, the steel temperature is calculated as follows.

$$Q_1 = Q_2 = U_1 A (T_1 - T_{steel}) = U_2 A (T_{steel} - T_2)$$

$$T_{steel} = \frac{U_1 T_1 + U_2 T_2}{U_1 + U_2}$$

2. 2-Dimensional heat transfer analysis model

- (1) In the analytical heat transfer analysis method, the heat transfer of the hull structure is considered in two dimensions. **Fig 2.5** shows the heat transfer path at the sideshell and bottom of the hull. The shape and heat transfer direction of the adjacent fluid (atmosphere or seawater) shown in **Fig 2.5** should be considered when performing analytical heat transfer analysis.

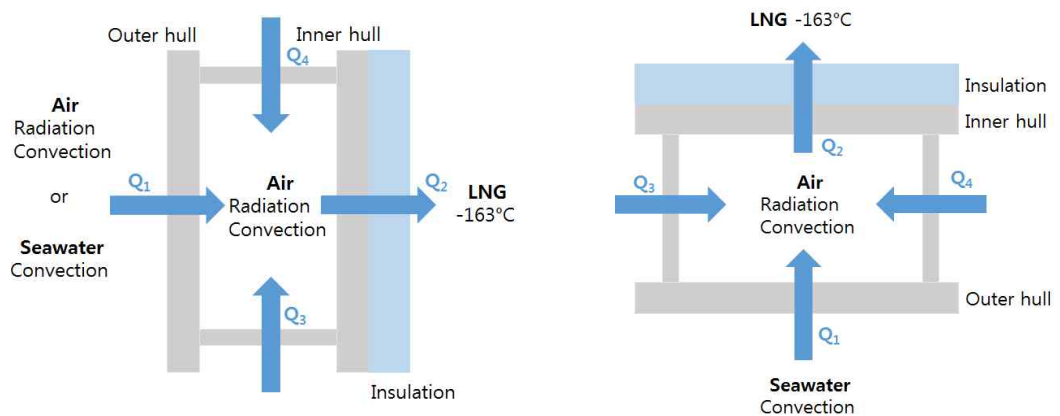

Fig 2.5 Example of two-dimensional heat transfer analysis model

- (2) The equilibrium equation of the analytical two-dimensional heat transfer analysis is described as follows.

$$\sum Q = Q_1 + Q_2 + Q_3 + Q_4 = 0$$

$$U_1 A_1 (T_E - T_C) + U_2 A_2 (T_C - T_L) + U_3 A_3 (T_{OC1} - T_C) + U_4 A_4 (T_{OC2} - T_C) = 0$$

T_E : Environmental temperature

T_C : Temperature of target compartment

T_L : Temperature of Liquefied gas

T_{OC} : Temperature of adjacent compartment

3. Basic heat transfer model

- (1) The one-and two-dimensional heat transfer analysis models are described as conduction heat transfer, convection heat transfer and radiation heat transfer.
- (2) Heat Transfer of Conduction
- (A) The heat transfer rate by conduction per unit area is described by the Fourier equation as follows.

$$q = -k \cdot \text{grad}(T)$$

q : Heat flux

k : Thermal conductivity

$grad(T) = \partial T / \partial n$ is the temperature derivative in vertical direction on isothermal temperature surface.

(B) The heat flux for a real structure is described as follows.

$$q = k(T_1 - T_2) / t$$

t : Thickness

(3) Heat Transfer of Convection

(A) Heat transfer coefficient of convection is described as follows.

$$q = h(T_1 - T_2)$$

h : Convective heat transfer coefficient

(B) Natural convection uses the Nusselt number to calculate the convective heat transfer coefficient.

$$h = \frac{N_u k}{L}$$

N_u : Nusselt number

k : Thermal conductivity

L : Characteristic length

(a) In hull structure, natural convection occurs in open spaces and also occurs in enclosed cofferdams.

(b) The Nusselt number for the vertical plate is obtained as shown in **Table 2.1**.

Table 2.1 Nusselt number for vertical plate

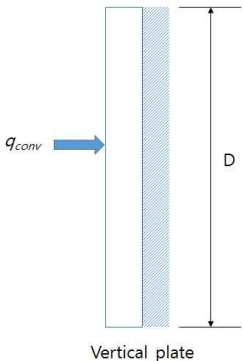
Shape	Characteristic length
 <p style="text-align: center;">Vertical plate</p>	D
R_a Range	Nusselt number, N_u
$\leq 10^9$	$N_u = 0.68 + \frac{0.670 Ra^{1/4}}{[1 + (0.492/P_r)^{9/16}]^{4/9}}$
$> 10^9$	$N_u = \left\{ 0.825 + \frac{0.387 Ra^{1/6}}{[1 + (0.492/P_r)^{9/16}]^{8/27}} \right\}^2$

(c) Rayleigh number(R_a) is calculated as follows.

$$R_a = G_r \cdot P_r$$

(d) Prandtl number(P_r) is calculated as follows.

$$P_r = \frac{\mu C_p}{k}$$

μ : Dynamic viscosity

C_p : Specific heat

k : Thermal conductivity

(e) Grashof number(G_r) is calculated as follows.

$$G_r = L^3 g \Delta T \beta \cos(\theta) / \nu^2$$

L : Characteristic length

g : Gravitational acceleration

ΔT : Temperature difference

β : Thermal expansion coefficient

θ : Plate angle($0 \leq \theta \leq 60^\circ$)

ν : Kinematic viscosity

(f) Nusselt number for horizontal plate is calculated as shown in **Table 2.2** and **Table 2.3**.

Table 2.2 Nusselt number for horizontal plate

Shape	Detail	Characteristic length
	Upper surface of a hot plate or lower surface of a cold plate	A_s/P A_s : surface area P : perimeter
R_a Range	Nusselt number, N_u	
$10^4 \sim 10^7$	$N_u = 0.54 R_a^{1/4}$	
$10^7 \sim 10^{11}$	$N_u = 0.15 R_a^{1/3}$	

Table 2.3 Nusselt number for horizontal plate

Shape	Detail	Characteristic length
	Lower surface of a hot plate or upper surface of a cold plate	A_s/P A_s : surface area P : perimeter
R_a Range	Nusselt number, N_u	
$10^5 \sim 10^{11}$	$N_u = 0.27 R_a^{1/4}$	

- (g) The Nusselt number for inclined plate in case of $\theta < 60^\circ$ is calculated by changing g of vertical Rayleigh number to $g \cos \theta$.

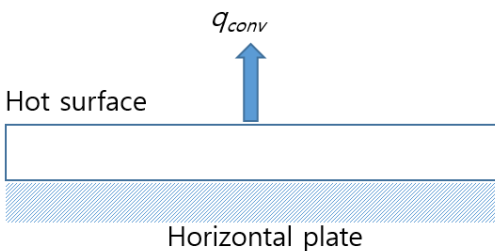
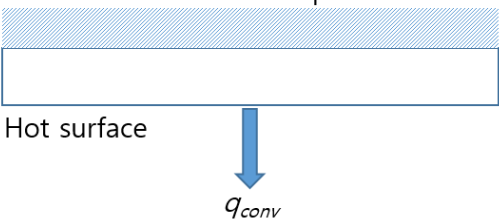
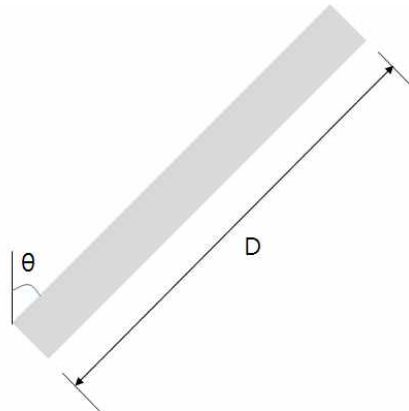

Fig 2.6 Inclined plate

- (C) Forced convection is calculated using the following formula (McAdams's formula) with the Nusselt number.

$$N_u = 0.037 \cdot R_e^{4/5} \cdot P_r^{1/3}$$

R_e : Reynolds number

P_r : Prandtl number

- (D) Fin effect of stiffener

- (a) ships carrying liquefied gases in bulk/ships using liquefied gases as fuels includes longitudinal and transverse stiffeners. These stiffeners affect the convective heat transfer coefficient, and the relationship can be expressed as:

$$h_{fin} = \Phi \cdot h$$

h : Heat transfer coefficient of convection

Φ : Coefficient of fin effect

- (b) The stiffeners act like fin and the fin effect can be expressed as:

$$\Phi = \frac{(A_{unfin} + \eta_{fin} A_{fin})(T_b - T_\infty)}{A_{nofin}(T_b - T_\infty)}$$

η_{fin} : Fin efficiency

T_b : Surface temperature

T_∞ : Temperature of inner compartment

A_{unfin} : The remaining area minus the fin portion

A_{nofin} : Area without fin

A_{fin} : Fin area

- (c) T-bars and angles should be replaced with flat bars considering only the web to consider the fin effect.

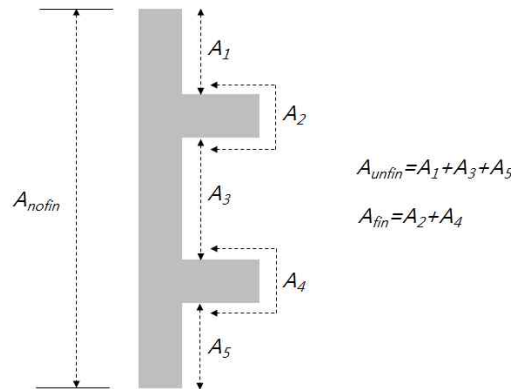

Fig 2.7 Shape definition for fin efficiency calculation

- (4) Radiation heat transfer
 (A) When heat transfer is performed by radiation, the relationship is as follows.

$$q = \varepsilon\sigma(T_1^4 - T_2^4)$$

σ : Stefan-Boltzmann constant, $5.6703 \times 10^{-8} \text{ W/m}^2 \text{ K}^{-4}$

ε : Emissivity

T_1 : Temperature of radiation surface

T_2 : Temperature of absorber

103. Material Properties

1. General

- (1) The designer is responsible for getting the material properties used in the heat transfer analysis.
- (2) The designer should evaluate the material properties including the cryogenic environment of liquefied gas.
- (3) Material properties can be obtained through the material supplier, the promulgated experimental data or the material experiments. If this is difficult, the specified values from 2. to 5. can be used.

2. Properties of steel

- (1) Refer Table 2.4 for thermal conductivity of steel plate.

Table 2.4 Thermal conductivity of steel plate

Material	Thermal Conductivity[W/mK]		
	0°C	-100°C	-163°C
Carbon steel	59		
2.5% Ni Steel	38	33	
3.5% Ni Steel	34	29	21
5.0% Ni Steel	31	26	19
9.0% Ni Steel	28	23	16

(2) Refer **Table 2.5** for emissivity of steel plate.

Table 2.5 Surface emissivity of carbon steel at room temperature

Steel shape	Temperature range(K)	Emissivity
Polished Sheet	300~500	0.08~0.14
Commercial Sheet	500~1200	0.20~0.32
Heavily oxidized	300	0.81

(3) The thermal conductivity for stainless steel and Invar(36% Ni steel) is obtained from the following formula, and the values in **Table 2.6** are used for the relevant constant.

$$\log_{10}k = a + b(\log_{10}T) + c(\log_{10}T)^2 + d(\log_{10}T)^3 + e(\log_{10}T)^4 + f(\log_{10}T)^5 + g(\log_{10}T)^6 + h(\log_{10}T)^7 + i(\log_{10}T)^8$$

Table 2.6 Coefficient of stainless steel & invar(36%Ni steel)

Coefficient	Stainless Steel(304, 304L, 316)	Invar(36% Ni Steel)
a	-1.408	22.0061
b	1.3982	-127.5528
c	0.2543	303.647
d	-0.6260	-381.0098
e	0.2334	274.0328
f	0.4256	-112.9212
g	-0.4658	24.7593
h	0.1650	-2.239153
i	-0.0199	0
Applicable temperature range(K)	1~300	100~300

3. Properties of seawater

(1) Refer **Table 2.7** for density of seawater.

Table 2.7 Density of seawater [kg/m³]

Seawater temperature[°C]	Salinity[‰]		
	20	30	40
0	1016.0	1024.0	1032.0
10	1015.2	1023.0	1030.9
20	1013.4	1021.1	1028.8
30	1010.7	1018.2	1025.8

(2) Refer **Table 2.8** for specific heat of seawater.

Table 2.8 Specific heat of seawater [kJ/kgK]

Seawater temperature[°C]	Salinity[‰]		
	20	30	40
0	4.080	4.020	3.963
10	4.079	4.023	3.969
20	4.078	4.025	3.974
30	4.079	4.028	3.979

(3) Refer **Table 2.9** for thermal conductivity of seawater.

Table 2.9 Thermal conductivity of seawater [W/mK]

Seawater temperature[°C]	Salinity[‰]		
	20	30	40
0	0.570	0.570	0.569
10	0.587	0.587	0.586
20	0.602	0.602	0.601
30	0.616	0.616	0.615

(4) Refer **Table 2.10** for kinematic viscosity of seawater.

Table 2.10 Kinematic viscosity of seawater [$10^{-7}m^2/s$]

Seawater temperature[°C]	Salinity[‰]		
	20	30	40
0	18.23	18.43	18.65
10	13.35	13.51	13.69
20	10.29	10.43	10.58
30	8.23	8.36	8.49

(5) Refer **Table 2.11** for prandtl number of seawater.

Table 2.11 Prandtl number of seawater

Seawater temperature[°C]	Salinity[‰]		
	20	30	40
0	13.25	13.31	13.40
10	9.41	9.48	9.56
20	7.06	7.12	7.19
30	5.51	5.57	5.63

4. Properties of air

(1) Refer **Table 2.12** for properties of air.

Table 2.12 Properties of air

Air temperature [°C]	Density [kg/m ³]	Specific heat [kJ/kgK]	Thermal conductivity [W/mK]	kinematic viscosity [10 ⁻⁶ m ² /s]	Thermal expansion [10 ⁻³ /K]	Prandtl Number
-150	2.793	1.026	0.0116	3.08	8.21	0.760
-100	1.980	1.009	0.0160	5.95	5.82	0.740
-50	1.534	1.005	0.0204	9.55	4.51	0.725
0	1.293	1.005	0.0243	13.3	3.67	0.715
20	1.205	1.005	0.0257	15.11	3.43	0.713
40	1.127	1.005	0.0271	16.97	3.20	0.711
60	1.067	1.005	0.0285	18.9	3.00	0.709

5. Properties of fresh water

(1) Refer **Table 2.13** for properties of fresh water.

Table 2.13 Properties of fresh water

Temperature [°C]	Density [kg/m ³]	Thermal conductivity [k, W/m · k]	Kinematic viscosity [μ , kg/m · s]	Prandtl Number, Pr	Volume expansion coefficient [β , 1/K]
0.01	999.8	0.561	1.792×10^{-3}	13.5	-0.068×10^{-3}
10	999.7	0.580	1.307×10^{-3}	9.45	0.733×10^{-3}
20	998.0	0.598	1.002×10^{-3}	7.01	0.195×10^{-3}
30	996.0	0.615	0.798×10^{-3}	5.42	0.294×10^{-3}
40	992.1	0.631	0.653×10^{-3}	4.32	0.377×10^{-3}
50	988.1	0.644	0.547×10^{-3}	3.55	0.451×10^{-3}
60	983.3	0.654	0.467×10^{-3}	2.99	0.517×10^{-3}
70	977.5	0.663	0.404×10^{-3}	2.55	0.578×10^{-3}
80	971.8	0.670	0.355×10^{-3}	2.22	0.653×10^{-3}
90	965.3	0.675	0.315×10^{-3}	1.96	0.702×10^{-3}
100	957.9	0.679	0.282×10^{-3}	1.75	0.750×10^{-3}

104. Calculation Conditions

1. Calculation conditions

- (1) To determine the grade of plate and sections used in the hull structure, a temperature calculation shall be performed for all tank types when the cargo temperature is below -10°C . The following assumptions shall be made in this calculation:
 - (A) The loading condition of the ship for the calculation is to be full loaded condition.
 - (B) Temperature distribution and heat transfer are to be dealt with as the phenomena in a steady state. No transient condition may be considered.
 - (C) the primary barrier of all tanks shall be assumed to be at the cargo temperature;
 - (D) The liquid cargo is to be assumed to have uniform temperature distribution.
 - (E) In addition to (C), where a complete or partial secondary barrier is required, it shall be assumed to be at the cargo temperature at atmospheric pressure for any one tank only;
 - (F) For worldwide service, ambient temperatures shall be taken as 5°C for air and 0°C for seawater. Higher values may be accepted for ships operating in restricted areas and, conversely, lower values may be fixed by the Society for ships trading to areas where lower temperatures are expected during the winter months. If necessary, refer to **Table 2.14**.

Table 2.14 Thermal design requirement in IGC and USCG Code

Regulation	Air temperature[$^{\circ}\text{C}$]	Temperature of seawater[$^{\circ}\text{C}$]	Wind speed[knots]
IGC Code	5.0	0.0	0.0
IGC Code, Warm condition	45.0	32.0	0.0
USCG, Excluding Alaskan water	-18.0	0.0	5.0
USCG, Alaskan water	-29.0	-2.0	5.0

- (G) still air and seawater conditions shall be assumed, i.e. no adjustment for forced convection;
- (H) Sea water is to be assumed to have a density of $1,025\text{kg}/\text{m}^3$ and a coagulation point of -2.5°C with physical properties compatible with those of fresh water for other items.
- (I) degradation of the thermal insulation properties over the life of the ship due to factors such as thermal and mechanical ageing, compaction, ship motion and tank vibrations shall be assumed;
- (J) the cooling effect of the rising boil-off vapour from the leaked cargo shall be taken into account, where applicable;
- (K) credit for hull heating may be taken in accordance with **2. (1)**, provided the heating arrangements are in compliance with **2. (2)**;
- (L) no credit shall be given for any means of heating, except as described in **2. (1)**;
- (M) The structures in hold space such as insulation materials and supports are to be assumed that they do not absorb liquid cargo.
- (N) In compartments where gases exist other than in hold spaces, it is to be assumed that they are in natural convection.
- (O) It is to be assumed that the gas and liquid within the same compartment are at the same temperature.
- (P) It is to be assumed that there is no transfer of gases within the insulation materials.
- (Q) It is to be assumed that there is no influence of moisture.
- (R) It is to be assumed that there is no influence of paints.
- (S) The overall heat transfer coefficients at various boundaries can be used with the numeral values given in **Table 2.15** of the Guidances, but calculation may be carried out by using empirical equations given in the heat transfer engineering data which has been made public. In this case, heat transfer due to radiation is also to be taken into account.
- (T) The substance for which temperature distribution is investigated to be assumed to be of homogeneous one without directivity.
- (U) Frames may be dealt with as fins.
- (V) In case where hold spaces located forward and afterward the hold space under study are in the same locations, they may be treated as a two dimensional problem.

Table 2.15 Overall heat transfer coefficient at various boundaries

Boundaries	Overall heat transfer coefficient(W/m ² °C)
Still gas ↔ Hull or liquid	5.8
Still sea water ↔ Hull	116.3
Cargo vapour ↔ Hull contacted to air	11.6

- (2) At the upright cargo leakage is to be considered for the calculation in accordance with the following (A) to (E). However, no leakage may be considered for integral tanks and type C independent tanks.
- (A) It is to be assumed that the failure of all cargo tanks located between transverse watertight bulkheads are caused. However, in case where the cross section of the ship is divided into more than one compartments by longitudinal bulkheads of the ship, it is to be assumed that the failure of all cargo tanks within each such compartment is caused.
- (B) It is to be assumed that the locations of the failure of the cargo tank cover all conceivable ones.
- (C) It is to be assumed that only the liquid cargo leaks out where the cargo tank, supports and hull remain intact without involving any deflections or fracture.
- (D) For cargo tanks where the complete secondary barrier is required, it is to be assumed that the leakage of liquid cargo occurs instantaneously and the levels of residual liquid cargo in damaged cargo tank and the leaked liquid level in the hold space reach the same level instantaneously.
- (E) The temperature of the secondary barrier in a state of leakage is to be assumed to be the same as the cargo temperature at the atmospheric pressure, whereas the temperature of the intact cargo tank is the design temperature. The ship is to be assumed to stay upright.
- (3) Secondary barrier shall also meet functional requirements at static heel condition of 30°.

2. Heating device

- (1) Means of heating structural materials may be used to ensure that the material temperature does not fall below the minimum allowed for the grade of material specified in **Table 2.16**. In the calculations required in **1. (1)**, credit for such heating may be taken in accordance with the following:
- (A) for any transverse hull structure;
- (B) for longitudinal hull structure referred to in **1. (2)** where colder ambient temperatures are specified, provided the material remains suitable for the ambient temperature conditions of 5°C for air and 0°C for seawater with no credit taken in the calculations for heating; and
- (C) as an alternative to (B), for longitudinal bulkhead between cargo tanks, credit may be taken for heating, provided the material remain suitable for a minimum design temperature of -30°C, or a temperature 30°C lower than that determined by **1. (1)** with the heating considered, whichever is less.
- (2) The means of heating referred to in (1) shall comply with the following requirements:
- (A) the heating system shall be arranged so that, in the event of failure in any part of the system, standby heating can be maintained equal to not less than 100% of the theoretical heat requirement;
- (B) the heating system shall be considered as an essential auxiliary. All electrical components of at least one of the systems provided in accordance with (1) (A) shall be supplied from the emergency source of electrical power; and
- (C) the design and construction of the heating system shall be included in the approval of the containment system by the Society.

105. Result Derivation

1. General

- (1) The steel grade of the structural members connecting the inner hull to the outer hull are determined using the average temperature.
- (2) The temperature of structural members is to be represented by the temperature at their half thickness, and for individual members, the following requirements (A) through (D) are to be complied with :
 - (A) The temperature of those frames fitted to plates is to be assumed to be the same as the temperature of the plates, but when the temperature distribution of the frame in the direction of depth is known, the area mean of the temperature distribution may be taken.
 - (B) The temperature of web frames supporting frames or plates is to be the temperature at their half depth for webs, and the temperature of face plates for these.
 - (C) The temperature of members connecting the inner shall and outer shell, e.g., brackets and girders is to be of the mean of the temperature of the inner shell and that of the outer shell.
 - (D) The temperature of brackets is to be the temperature at their centroid.

2. Selection of steel grade

- (1) The grade of plate and sections used in the hull structure shall be selected in accordance with a temperature calculation when the cargo temperature is below -10°C .
- (2) The shell and deck plating of the ship and all stiffeners attached thereto shall be in accordance with the requirements of Pt 3 of the Rules, if the calculated temperature of the material in the design condition is below -5°C due to the influence of the cargo temperature, the material shall be in accordance with **Table 2.16**.
- (3) The materials of all other hull structures for which the calculated temperature in the design condition is below 0°C , due to the influence of cargo temperature and that do not form the secondary barrier, shall also be in accordance with **Table 2.16**. This includes hull structure supporting the cargo tanks, inner bottom plating, longitudinal bulkhead plating, transverse bulkhead plating, floors, webs, stringers and all attached stiffening members.

Table 2.16 Plates and sections for hull structures

Minimum design temperature of hull structure($^{\circ}\text{C}$)	Maximum thickness(mm) for steel grades							
	A	B	D	E	AH	DH	EH	FH
0 and above ⁽¹⁾ -5 and above ⁽²⁾	standards deemed appropriate by the our Society							
down to -5	15	25	30	50	25	45	50	50
down to -10	×	20	25	50	20	40	50	50
down to -20	×	×	20	50	×	30	50	50
down to -30	×	×	×	50	×	20	40	50
Below -30	In accordance with Rules for the Classification of Steel Ships, Pt 7 Chapte 5 Table 7.5.5 except that the thickness limitation given in Rules for the Classification of Steel Ships, Pt 7 Chapter 5 Table 7.5.5 and in note (2) of that table does not apply.							
(Notes) “×” means steel grade not to be used. (1) For the purpose of 502. 3 (2) For the purpose of 502. 2								

- (4) According to USCG code, the deck stringer and sheer strake must be at least Grade E steel. The strake at the turn of the bilge must be Grade D or Grade E. Application range is to follow **Table 2.17**.

Table 2.17. Application range for structural member

structural member category	Application range
deck stringer	Within 0.4L amidships
sheer strake	Within 0.4L amidships
bilge	Within 0.4L amidships

3. Selection of welding consumables

- (1) Application of welding consumables for welded joints of various grades of steel is to be as specified in **Table 2.18**.
- (2) Welding consumables for lower toughness of steel may be used for welded joints of different toughness of steel of the same specified strength.
- (3) In case of welding of steels of different specified strength, the welding consumables required for the steel of lower specified strength may be used, provided that adequate means for preventing cracks are considered.
- (4) It is recommended that controlled low hydrogen type consumables are to be used when joining higher strength structural steel to the same or lower strength level, except that other consumables may be used at the discretion of the Society when the carbon equivalent is below or equal to 0.41%. When other than controlled low hydrogen type electrodes are used, appropriate procedure tests for hydrogen cracking may be conducted at the discretion of the Society. ↓

Table 2.18 Selection of welding consumables

Kind and grade of steel to be welded		Grade of applicable welding consumables ⁽¹⁾	
Rolled steels for hull	Mild steel	A	1, 2, 3, 1Y, 2Y, 3Y, 4Y, 5Y, 2Y40, 3Y40, 4Y40, 5Y40, L1, L2, L3
		B, D	2, 3, 1Y, 2Y, 3Y, 4Y, 5Y, 2Y40, 3Y40, 4Y40, 5Y40, L1, L2, L3
		E	3, 3Y, 4Y, 5Y, 3Y40, 4Y40, 5Y40, L1, L2, L3
	Higher strength low alloy steel	AH32, AH36	1Y ⁽²⁾ , 2Y, 3Y, 4Y, 5Y, 2Y40, 3Y40, 4Y40, 5Y40, L2 ⁽³⁾ , L3, 2Y42, 3Y42, 4Y42, 5Y42
		DH32, DH36	2Y, 3Y, 4Y, 5Y, 2Y40, 3Y40, 4Y40, 5Y40, L2 ⁽³⁾ , L3, 3Y42, 4Y42, 5Y42
		EH32, EH36	3Y, 4Y, 5Y, 3Y40, 4Y40, 5Y40, L2 ⁽³⁾ , L3, 4Y42, 5Y42
		FH32, FH36	4Y, 5Y, 4Y40, 5Y40, L2 ⁽³⁾ , L3, 4Y42, 5Y42
		AH40, DH40	2Y40, 3Y40, 4Y40, 5Y40, 3Y42, 4Y42, 5Y42, 2Y46, 3Y46, 4Y46, 5Y46
		EH40	3Y40, 4Y40, 5Y40, 3Y42, 4Y42, 5Y42, 3Y46, 4Y46, 5Y46
		FH40	4Y40, 5Y40, 4Y42, 5Y42, 4Y46, 5Y46
NOTES :			
(1) The symbol of welding consumables listed above show the materials which are specified in Rules for the Classification of Steel Ships, Pt 2 Table 2.2.16, Table 2.2.26, Table 2.2.34, Table 2.2.40 and Table 2.2.68 .			
(2) When joining higher strength steels using grade 1Y welding consumables, the material thickness should not exceed 25mm.			
(3) Welding consumables of "L2" is applicable to steel grade of AH32, DH32, EH32 or FH32.			

Section 2 FEM HEAT TRANSFER ANALYSIS

201. Modeling

1. 2-Dimensional heat transfer

- (1) The two-dimensional heat transfer analysis model is performed using a solid element or a shell element. When it is necessary to consider the temperature distribution in the thickness direction, the solid element should be used.
- (2) When solid elements are used, the mesh size shall not be greater than 200mm*200mm and shall be divided into two or more elements in the thickness direction. An example of a two-dimensional heat transfer model is shown in **Fig 2.8**.
- (3) When using a shell element, the mesh size should be 200mm*200mm or less.

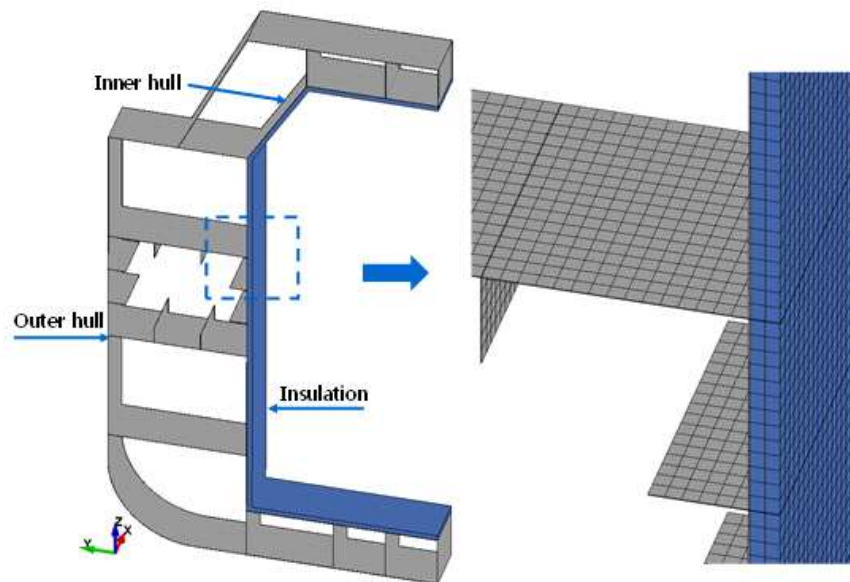

Fig 2.8 Model for 2-dimensional heat transfer analysis

2. 3-Dimensional heat transfer

- (1) When the analysis considering cofferdams is required, the heat transfer analysis model should be extended to both sides of the bulkhead of the cofferdam, and three-dimensional heat transfer analysis considering the length direction of the hull should be performed.
- (2) The insulation and bulkhead are modeled on the LNG side of the inner hull.
- (3) The transverse bulkhead should be considered in the finite element heat transfer analysis model. The bulkhead should only be insulated on the LNG contact surface and have a stiffener on the other side.
- (4) The three-dimensional heat transfer analysis model is performed using a solid element or a shell element. When it is necessary to consider the temperature distribution in the thickness direction, the solid element should be used.
- (5) When solid element are used, the mesh size shall not be greater than 200mm*200mm and shall be divided into two or more elements in the thickness direction. An example of a three-dimensional heat transfer model is shown in **Fig 2.9**.
- (6) When using a shell element, the mesh size should be 200mm*200mm or less.

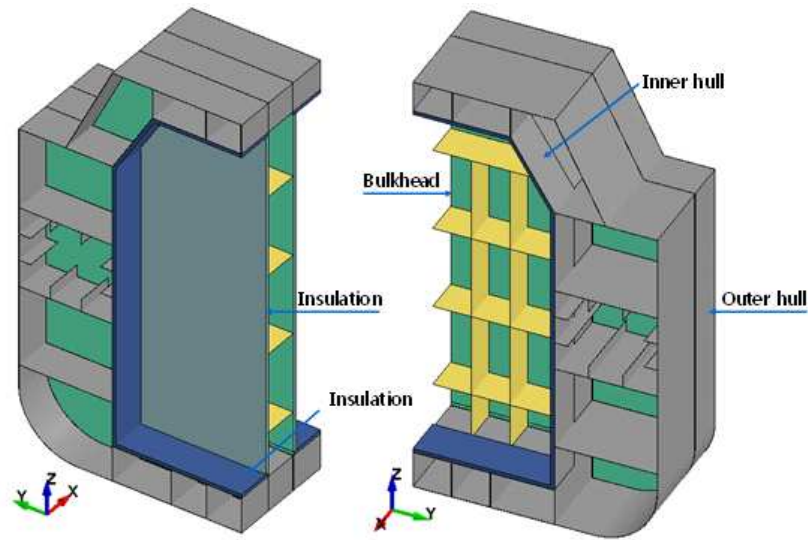

Fig 2.9 Model for 3-dimensional heat transfer analysis

202. Material Properties

1. General

(1) Follow Ch 2, Sec 1, 103..

203. Calculation Conditions

1. General

(1) Follow Ch 2, Sec 1, 104..

(2) Convection, radiation and conduction according to the environment of each member should be considered as shown in Figure 2.10 and Table 2.19.

(3) The temperature and heat transfer coefficient in Table 2.19 shall be entered base on the results of Ch 2, Sec 2.

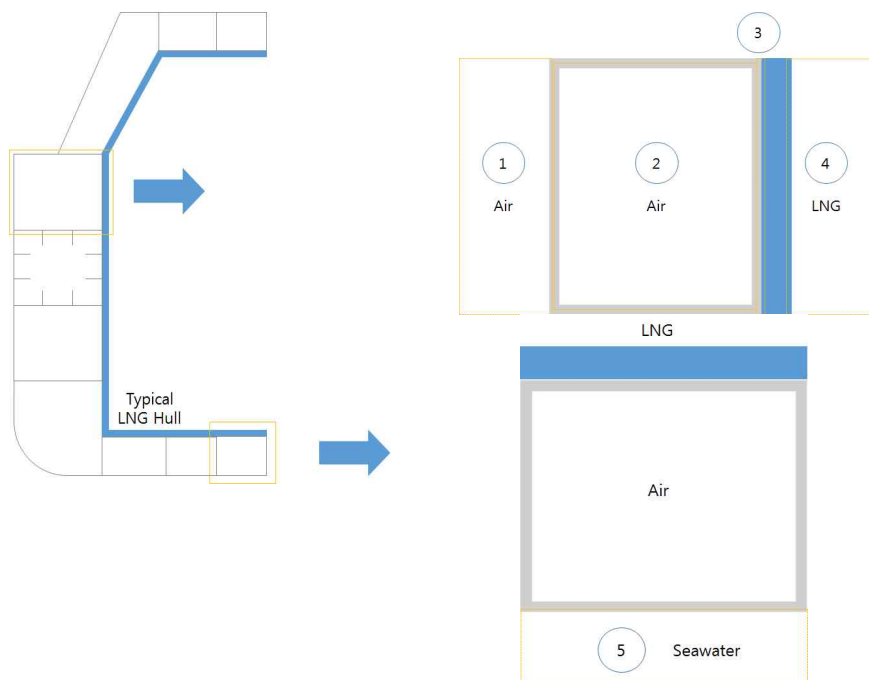
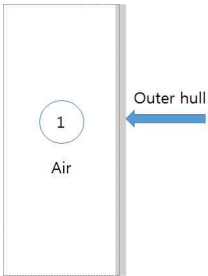
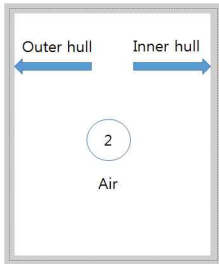
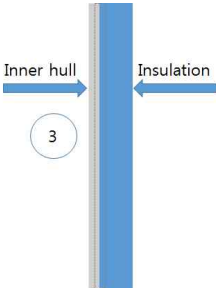
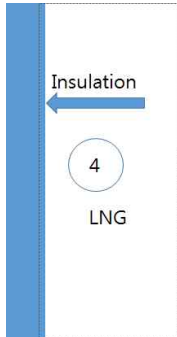
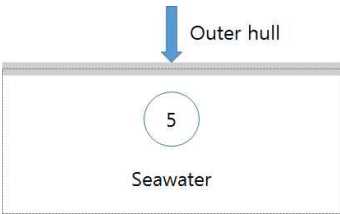

Fig 2.10 Finite element modeling in heat transfer analysis of liquefied gas carrier hull

Table 2.19 Heat transfer process in heat transfer analysis

Structural part	Heat transfer process	Input for FEM analysis
	Radiation	Air temperature Emissivity of outer hull surface
	Convection	Air temperature Convective heat transfer coefficient
	Conduction	Not considered
	Radiation	Air temperature of compartment View factor of compartment surface Emissivity of compartment surface
	Convection	Air temperature of compartment Convective heat transfer coefficient
	Conduction	Thermal conductivity and specific heat of steel
	Radiation	Not considered
	Convection	Not considered
	Conduction	Thermal conductivity and specific heat of steel and insulation
	Radiation	Not considered The temperature of liquefied gas is applied on the secondary barrier.
	Convection	Not considered The temperature of liquefied gas is applied on the secondary barrier.
	Conduction	Not considered The temperature of liquefied gas is applied on the secondary barrier.
	Radiation	Not considered
	Convection	Seawater temperature Convective heat transfer coefficient
	Conduction	Not considered

204. Result Derivation

1. General

(1) Follow Ch 2, Sec1, 105., 1.

2. Selection of steel grade

(1) Follow Ch 2, Sec 1, 105., 2.

(2) As shown in Figure 2.11, the steel of cofferdam surrounded by the design lower water line above and intersecting line between inner hull and cofferdam and steel inside 500mm from intersecting line between inner hull and cofferdam should be selected based on the temperature of mid-section of membrane tank.

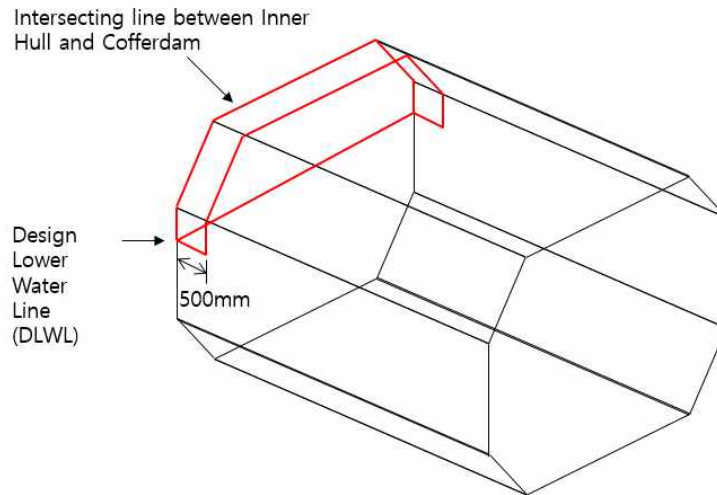

Figure 2.11 Important consideration range in steel selection

3. Selection of welding consumable

(1) Follow Ch 2, Sec 1, 105., 3.

(2) Selection of welding consumable is based on the steel grade determined using the average temperature of the member. ↓

CHAPTER 3 HEAT TRANSFER ANALYSIS FOR INDEPENDENT TYPE A TANK

Section 1 Analytical Heat Transfer Analysis

101. Analysis Procedure

1. Follow Ch 2, Sec 1, 101.

102. Modeling

1. Follow Ch 2, Sec 1, 102.

103. Material Properties

1. Follow Ch 2, Sec 1, 103.

104. Calculation Conditions

1. Follow Ch 2, Sec 1, 104.

105. Result Derivation

1. Follow Ch 2, Sec 1, 105.
2. **Figure 3.1** illustrates calculation results performed for a midship section of a type A LNG Carrier using analytical method.

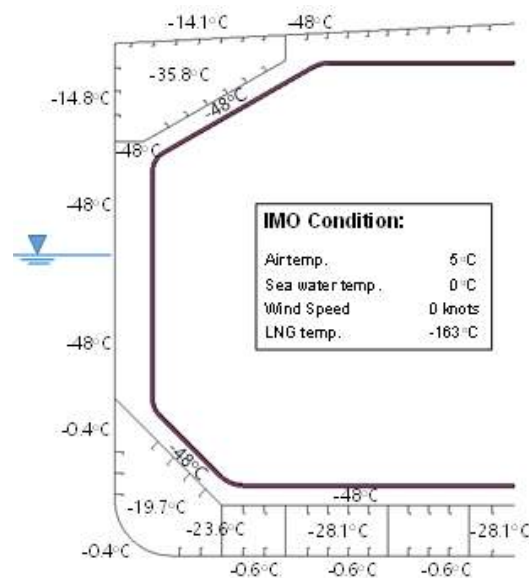

Figure 3.1 Temperature calculation for Type A tank using analytical method

Section 2 FEM HEAT TRANSFER ANALYSIS

201. Modeling

1. Follow Ch 2, Sec 2, 201.
2. The heat transfer of conduction through the supports(including vertical, anti rolling, anti pitching and anti floating) connecting the cargo tank with the inner hull should be considered.

202. Material Properties

1. Follow Ch 2, Sec 2, 202.

203. Calculation Conditions

1. Follow Ch 2, Sec 2, 203.

204. Result Derivation

1. Follow Ch 2, Sec 2, 204.
2. A sample 2D model of the Type A hull for heat transfer analysis is presented in Figure 3.2.
3. As shown 'd' in Figure 3.3., the steel on the secondary barrier should be extended 500mm toward the centerline from the intersection between the deck plate and a line at a static heel of ± 30 degrees, inside the top side tank and hopper tank.

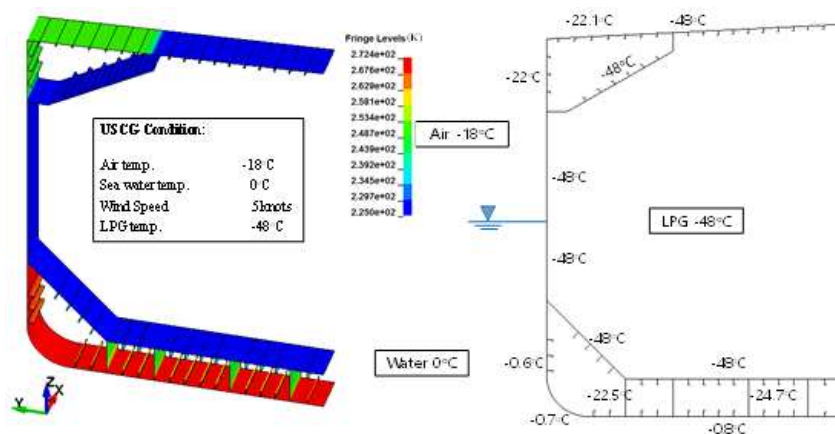

Figure 3.2 Temperature calculation for Type A tank using 2D FEM

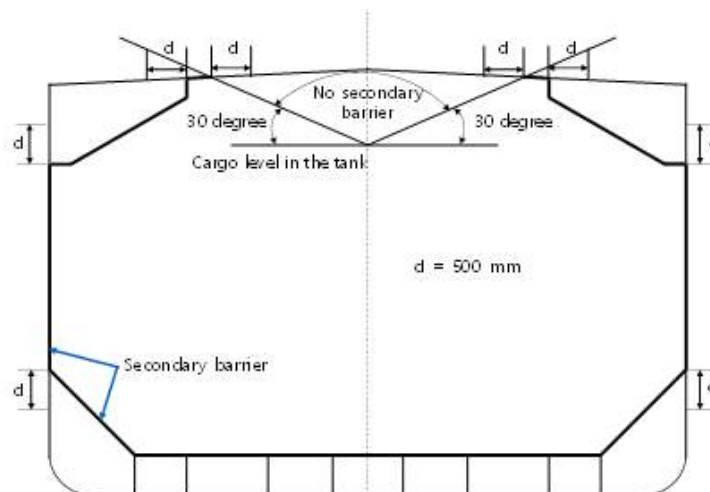

Figure 3.3 Application range extension of secondary steel for Type A tank

CHAPTER 4 HEAT TRANSFER ANALYSIS FOR INDEPENDENT TYPE B TANK

Section 1 Analytical Heat Transfer Analysis

101. Analysis Procedure

1. Follow Ch 2, Sec 1, 101.

102. Modeling

1. Follow Ch 2, Sec 1, 102.

103. Material Properties

1. Follow Ch 2, Sec 1, 103.

104. Calculation Conditions

1. Follow Ch 2, Sec 1, 104.

105. Result Derivation

1. Follow Ch 2, Sec 1, 105.
2. **Figure 4.1** illustrates a temperature calculation results performed for a midship section of a Type B LNG carrier using analytical method.

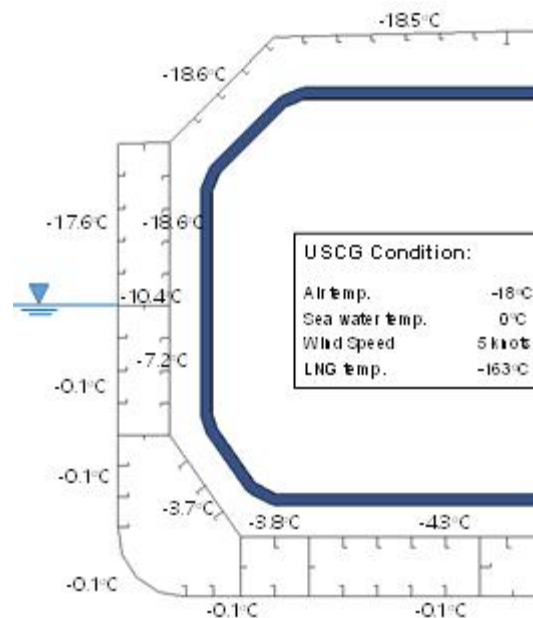

Figure 4.1 Temperature calculation for Type B tank using analytical method

Section 2 FEM HEAT TRANSFER ANALYSIS

201. Modeling

1. Follow Ch 2, Sec 2. 201.
2. The temperature calculation of independent type B tank is similar with the membrane type, but need to consider the gap between inner hull and the cargo tank. The heat transfer of conduction through the supports(including vertical, anti rolling, anti pitching and anti floating) connecting the cargo tank with the inner hull should be considered.

202. Material Properties

1. Follow Ch 2, Sec 2. 202.

203. Calculation Conditions

1. Follow Ch 2, Sec 2. 203.
2. Figure 4.2 and Table 4.1 presents the application of FEM to modeling of overall heat transfer in the independent type B tank and the required input data for each form of heat energy transfer.

204. Result Derivation

1. Follow Ch 2, Sec 2. 204.
2. Figure 4-3 is one example of temperature analysis result for 2D FEM midship section.
3. Figure 4-4 illustrates a temperature calculation results performed for 3D FEM including cofferdam.

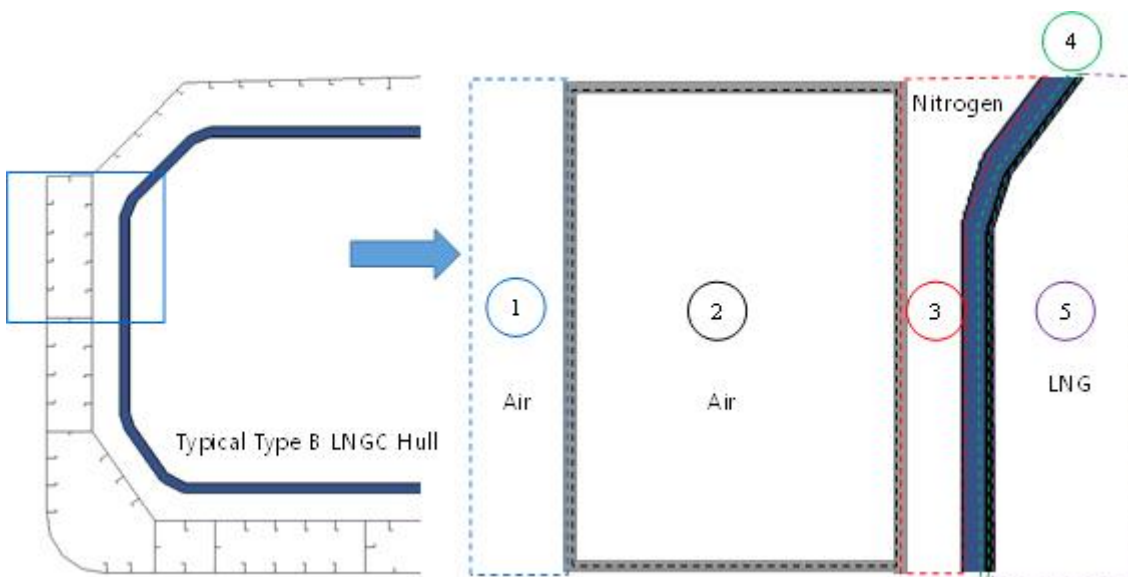
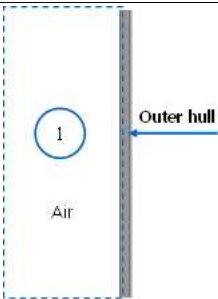
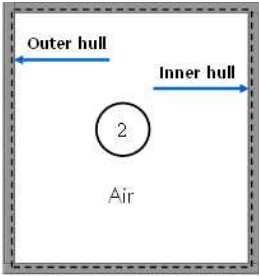
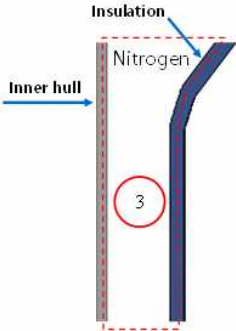
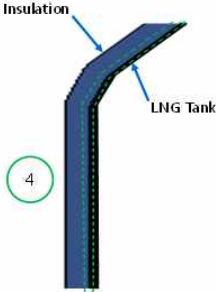
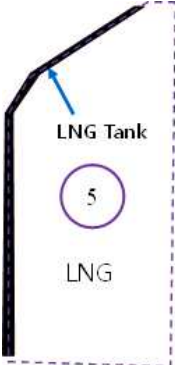

Figure 4.2 Finite element modeling in heat transfer analysis of hull with independent type B tank at Temperature calculation

Table 4.1 Heat transfer process in heat transfer analysis for hull with independent type B tank

Parts	Heat Transfer Process	Required input data in FEM
	Radiation	Air temperature Outer hull surface emissivity
	Convection	Air temperature Convective heat transfer coefficient
	Conduction	Not considered
	Radiation	View factor of the enclosure surfaces Emissivity of enclosure surfaces
	Convection	Air properties such as conductivity and specific heat Convection heat transfer coefficient
	Conduction	Steel conductivity and specific heat
	Radiation	View factor of the enclosure surface Emissivity of enclosure surface
	Convection	Nitrogen properties such as conductivity and specific heat Convection heat transfer coefficient
	Conduction	Not considered
	Radiation	Not considered
	Convection	Not considered
	Conduction	Thermal material properties of insulation and LNG tank material such as conductivity and specific heat
	Radiation	Not considered
	Convection	Not considered The temperature of liquefied gas is applied on the primary barrier.
	Conduction	Not considered The temperature of liquefied gas is applied on the primary barrier.

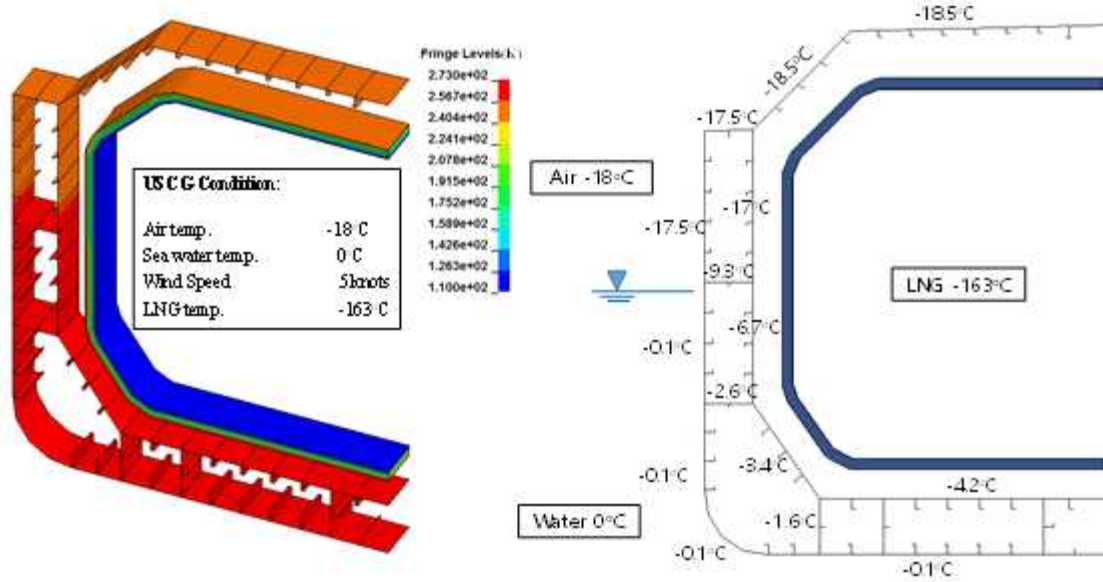

Figure 4-3 Temperature distribution calculation by 2D FEM heat transfer analysis

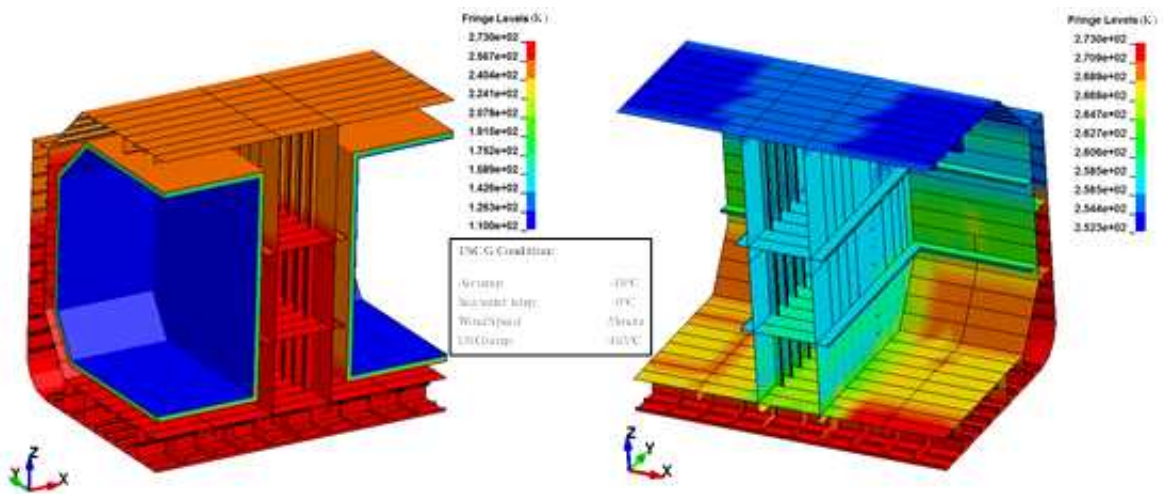

Figure 4-4 Temperature distribution in the cofferdam calculated by 3D FEM heat transfer analysis



CHAPTER 5 HEAT TRANSFER ANALYSIS FOR INDEPENDENT TYPE C TANK

Section 1 Analytical Heat Transfer Analysis

101. Analysis Procedure

1. Follow Ch 2, Sec 1. 101.

102. Modeling

1. Follow Ch 2, Sec 1. 102.

103. Material Properties

1. Follow Ch 2, Sec 1. 103.

104. Calculation Conditions

1. Follow Ch 2, Sec 1. 104.

105. Result Derivation

1. Follow Ch 2, Sec 1. 105.

Section 2 FEM HEAT TRANSFER ANALYSIS

201. Modeling

1. Follow Ch 2, Sec 2. 201.
2. The heat transfer of conduction through the support (cradle support or sliding support) should be considered. In the case of bilobe, heat transfer of conduction through the cradle support and anti-floating support should be considered.

202. Material Properties

1. Follow Ch 2, Sec 2. 202.

203. Calculation Conditions

1. Follow Ch 2, Sec 2. 203.

204. Result Derivation

1. Follow Ch 2, Sec 2. 204. ↓

**Guidances of Heat Transfer Analysis
for Ships Carrying Liquefied Gases
in Bulk/Ships Using Liquefied
Gases as Fuels**

Published by

KR

36, Myeongji ocean city 9-ro, Gangseo-gu,
BUSAN, KOREA

TEL : +82 70 8799 7114

FAX : +82 70 8799 8999

Website : <http://www.krs.co.kr>

Copyright© 2021, KR

Reproduction of this Guidances in whole or in parts is
prohibited without permission of the publisher