



2021

Rules and Guidance for the Classification of
Underwater Vehicles

2021

Rules for the Classification of

Underwater Vehicles

Rules

2021

Guidance Relating to the Rules for the Classification of

Underwater Vehicles

Guidance



2021

Rules for the Classification of
Underwater Vehicles

**APPLICATION OF
"UNDERWATER VEHICLES"**

1. Unless expressly specified otherwise, the requirements in these Rules apply to ships for which contracts for construction are signed on or after 1 July 2012.
2. The amendments to the Rules for 2011 edition and their effective date are as follows;

Effective Date 1 July 2021

<No revision>

CONTENTS

PART 1 SUBMERSIBLES

CHAPTER 1 GENERAL	3
Section 1 General	3
Section 2 Drawings and Documents	4
Section 3 Tests and Trials	8
Section 4 Marking	11
CHAPTER 2 CLASSIFICATION OF SUBMERSIBLE	13
Section 1 Classification Registry	13
Section 2 Classification Survey during Construction	13
Section 3 Classification Survey after Construction	14
CHAPTER 3 PERIODICAL AND OTHER SURVEY	15
Section 1 Kinds of Surveys	15
Section 2 Performance of Survey	15
CHAPTER 4 DESIGN REQUIREMENTS	17
Section 1 General	17
Section 2 Environmental Conditions	17
Section 3 Hatches, Doors and Access Ports	18
Section 4 Equipment	18
Section 5 Corrosion Protection	19
CHAPTER 5 PRESSURE HULL	21
Section 1 General	21
Section 2 Design Principles	21
Section 3 Materials and Weldings	22
Section 4 Principles of Manufacture and Construction	23
Section 5 Calculations	25
CHAPTER 6 EXTERNAL STRUCTURE	29
Section 1 General	29
CHAPTER 7 DIVING AND BUOYANCY TANKS AND TRIMMING DEVICES	31
Section 1 General	31
Section 2 Principles of Design and Construction	31
Section 3 Materials, Manufacture and Calculations	32
CHAPTER 8 PRESSURE VESSELS AND APPARATUS	33
Section 1 General	33

Section 2	Compression Chambers and Diving Bells	33
Section 3	Pressure Vessels and Apparatus and Gas Bottles	33
CHAPTER 9	PIPING SYSTEMS, PUMPS AND COMPRESSORS	35
Section 1	General	35
Section 2	Principles of Design and Construction	35
Section 3	Materials, Manufacture and Calculations	36
CHAPTER 10	CONTROL SYSTEMS FOR DEPTH, TRIM, POSITIVE AND NEGATIVE BUOYANCY	37
Section 1	General	37
Section 2	Principles of Design and Construction	37
CHAPTER 11	PROPULSION AND MANOEUVRING EQUIPMENT	39
Section 1	General	39
Section 2	Principles of Design and Construction	39
CHAPTER 12	ELECTRIC EQUIPMENT	41
Section 1	General	41
Section 2	Design Principles	41
Section 3	Power Supply	43
CHAPTER 13	AUTOMATION, COMMUNICATION, NAVIGATING AND LOCATING EQUIPMENT	49
Section 1	General	49
Section 2	Automation Equipment	49
Section 3	Control System	51
Section 4	Communication Equipment	52
Section 5	Navigating and Locating Equipment	53
CHAPTER 14	LIFE SUPPORT SYSTEMS	55
Section 1	General	55
Section 2	Design Principles	55
Section 3	Air Supply	55
Section 4	Monitoring Equipment	57
Section 5	Emergency Thermal Protection	57
CHAPTER 15	FIRE PROTECTION AND FIRE EXTINGUISHING	59
Section 1	General	59
Section 2	Structural Fire Protection	59
Section 3	Fire Surveillance	59
Section 4	Fire Extinguishing Systems	60

CHAPTER 16 RESCUE SYSTEM	61
Section 1 General	61
Section 2 Design Principles	61
CHAPTER 17 LAUNCH, RECOVERY AND MATING EQUIPMENT	63
Section 1 General	63
Section 2 Design Principles	63
Section 3 Materials	64
Section 4 Principles of Manufacture and Construction	64
Section 5 Calculations	65
 PART 2 REMOTE-OPERATED VEHICLES	
CHAPTER 1 REMOTE-OPERATED VEHICLES (ROVs)	69
 PART 3 TOURIST SUBMERSIBLES	
CHAPTER 1 TOURIST SUBMERSIBLES	73

PART 1
SUBMERSIBLES

CHAPTER 1 GENERAL

Section 1 General

101. Application

1. The requirements of this Part apply to surface dependent or surface independent submersible. Rules for Classification Steel Ships may be applied to the Submersible for the unspecified in this Rule.
2. For the submersible equipping the diver's lock-out system, it is to be complied with **Pt 9, Ch 7 of Rules for the Classification of Steel Ships** in addition to this Part.
3. In case of surface dependent submersible, the classification also extends to systems and equipment on the support ship or support station which are needed to supply the submersible.
4. Designs differing from this Part of Construction may be permitted provided their suitability has been verified by the Society and they have been recognized as equivalent.
5. Submersibles and their parts thereof whose development is based on new principles and which have not yet been sufficiently tested in practical operation require special approval by the Society.

102. Definition

For the purpose of this Part the terms used therein is to be as followings in addition to **Pt 9, Ch 7, 602 of Rules for the Classification of Steel Ships**.

1. Submersible

A submersible means manned surface dependent or surface independent submersible capable of operating underwater.

2. Surface independent (Autonomous) submersible

A submersible capable of operating offshore without a support ship.

3. Pressure hull

A pressure hull means the main component of a submersible which accommodates the crew at atmospheric pressure and withstands the diving pressure.

4. External structure

An external structure means external cladding, supporting structures and fixtures outside the pressure hull which are not normally designed to withstand the diving pressure.

5. Viewport

A viewport means openings in pressure hulls or compression chambers for fitting pressure tight, flat or spherical acrylic windows.

6. Release equipment

A release equipment means the mass capable of decreasing the total mass of submersible. It may be used for the when the submersible can not buoy by buoyancy.

7. Diver's lockout

A diver's lockout means a compression chamber including exit hatch in a submersible for the entry, egress and accommodation of divers at diving pressure operating limits for launching and retrieval(seaway) other operating limits.

8. Control Station

A control station means central station at which all essential indicators, controls, regulating devices, monitoring devices, communication systems of the submersibles are arranged.

9. Total system

A total system means the submersible including its mating, handling, retrieval, working and supply systems and ancillary equipment.

10. Maximum diving depth

A maximum diving depth means the depth where the submersible can be operated safely is measured from the keel of the submersible to the surface.

11. Maximum permissible diving pressure

A maximum permissible diving pressure means the pressure is in accordance with maximum diving depth.

12. Design pressure

A design pressure means the maximum permissible diving pressure

13. Test depth

A test depth means the depth corresponds to the external pressure to which the submersible is to be subjected on completion. The depth is measured to the underside of the pressure hull.

14. Destructive depth

A destructive depth means the calculated external pressure liable to cause collapse of the pressure hull.

15. Support ship/station

A support ship/station means a surface vessel or station for supporting and supplying non-autonomous submersibles.

16. Maximum design mission time

The maximum design mission time means a maximum effective recharging interval for life support, compressed air and electrical systems for which the submersible is designed and approved to perform the intended function under normal operating conditions.

Section 2 Drawings and Documents

201. General

1. Before the start of manufacture, plans of the total system and drawings of all components subject to compulsory inspection, wherever applicable and to the extent specified below, are to be submitted to this Society with 3 copies including 1 copy for approval. All corrective actions are to be treated and approved by the Society before they are implemented.
2. The drawings are to contain all the data necessary to check the design and loading of the equipment. Wherever necessary, calculations relating to components and descriptions of the system are to be submitted.

202. Total system

The following documents are to be submitted:

1. A description of the submersible with details of its mode of operation, the proposed application and the essential design data including:
 - (1) Maximum diving depth
 - (2) Maximum operating time and maximum survival time
 - (3) Maximum number of persons in pressure hull
 - (4) Divers' compression chamber

- (5) Diving procedure
 - (6) Operating limits for launching and retrieval (seaway)
 - (7) Other operating limits (e.g. associated with geographical factors or current)
 - (8) Speed
 - (9) Type of drive and manoeuvring equipment
 - (10) Weight of vehicle, useful load and ballast, displacement (submerged).
2. General drawing and plans showing arrangement and design details of the submersible, including specifications for materials, manufacture and testing
 3. In the case of submersibles operated from support ships or stations, arrangement drawings (block diagrams) of the total system are to be submitted together with details of the equipment provided for the supply and support of the submersible (e.g. handling and retrieval system, gas supply, compression chamber system, dynamic positioning system, battery charging facilities etc.)
 4. A comprehensive presentation of the measures taken to prevent corrosion
 5. Trial program

203. Pressure Hull

1. Drawings and calculations for the pressure hull are to be submitted with all essential particulars and details necessary for appraising the safety of the equipment and including the specifications for materials, manufacture and testing. The drawings are to show all the internal and external fixtures of the pressure hull (e.g. strengthening ribs, machine bed plates, mountings etc.).
2. In addition, component drawings of the pressure hull equipment are to be submitted including:
 - (1) Entry and exit hatches
 - (2) Windows, window flanges and counter flanges
 - (3) Door panels and door frames
 - (4) Block flanges
 - (5) Pressure hull wall penetrations and their arrangement
 - (6) Diver's lockout.

204. External structure

Plans and sectional drawings of the vehicle envelope and supporting structure are to be submitted including details of such pressure hull fixtures as diving tanks, gas tanks, buoyancy tanks, stabilizing fins, rudder, disengaging gear, keel runners, anti ramming device, streamlining elements, manipulators, instrument mountings, anchor etc.

205. Diving and buoyancy tanks, trimming devices

Arrangement details of diving, regulating and trimming tanks with mathematical proof of the vehicle's static diving capability and stability when submerged and on the surface, including the intermediate conditions occurring when the vehicle is diving or surfacing both normally and in emergency situations.

206. Pressure vessels and apparatus

Drawings of the pressure vessels and apparatus are to be submitted with all essential particulars and details necessary for appraising the safety of the equipment and including the specifications for materials, manufacture and testing.

207. Piping systems, pumps and compressors

For the piping systems, pumps and compressors, the following are to be submitted:

1. Schematic diagrams of all piping systems including details of:
 - (1) Materials
 - (2) Maximum working pressure/temperature
 - (3) Dimensions (diameter, wall thickness)

- (4) Media carried
 - (5) Type of valves and connections used
 - (6) Type of hoses used.
2. Description of pumps, compressors and their drives together with all important design and operating data.

208. Control systems for depth, trim and positive and negative buoyancy

Description of the control systems for depth, trim and positive and negative buoyancy as well as of the safety devices to prevent the maximum diving depth from being exceeded, including the necessary piping diagrams and component drawings. This includes drawings of:

1. Compressed air system for blowing diving tanks
2. Freeing and ballast systems
3. Rigid buoyancy elements and their mountings
4. Weights and gear capable of being jettisoned and their means of release.

209. Propulsion and manoeuvring equipment

Drawings and descriptions are to be submitted of the propulsion and manoeuvring equipment including gears, couplings, shafting, propellers and rudders with details of:

1. Mode of operation and control of the systems
2. Power consumption (type and quantity)
3. Method of power transmission to propulsion unit
4. Seals of pressure hull wall penetrations
5. Operating range and response time of rudder.

210. Electrical equipment

The following are to be submitted:

1. A general arrangement drawing of the electrical equipment containing at least the following information:
 - (1) Voltage rating of the systems
 - (2) Power or current ratings of electrical consumers
 - (3) Switchgear, indicating settings for short-circuit and overload protection:
fuses with details of current ratings
 - (4) Cable types and cross sections.
2. The energy balance of the main and emergency power supply systems.
3. Drawings of switchgear and distribution equipment with parts lists.
4. Complete documentation for electric motor drives with details of control, measuring and monitoring systems.
5. Battery installation drawing with details of battery types, chargers and battery room ventilation.
6. Details of electrical penetrations through pressure hull walls.
7. Diagrams showing allocation of pressure hull wall penetrations.
8. Diagrams showing arrangement of emergency light fittings.
9. Calculation of short circuit conditions with details of circuit breakers, power protection switches and fuses fitted to main and emergency switchboards and distribution boards indicating their current ratings and breaking capacity.
10. The installer of the electrical equipment is to submit confirmation on the effect that the electrical equipment in hazardous areas is of explosion proof design.

211. Automation, communications, navigation and locating systems

For the automation, communications, navigation and locating systems, the following are to be submitted:

1. Description of the complete instrumentation layout.
2. Description of the control and operating elements for the submersible and its equipment.
3. Description of the nautical and diving instrumentation, including speed and position indicators.
4. A description of the safety and alarm systems.
5. Arrangement drawings/block diagrams of monitoring systems including lists of measuring points.
6. Documentation for electronic components such as instrument amplifiers, computers and peripheral units.
7. General diagrams and equipment lists for the communication systems and signalling equipment.
8. General diagram and description of the TV system.
9. Descriptions, general diagrams and equipment lists for the locating equipment.

212. Life support systems

For the life support systems, the following are to be submitted:

1. Piping diagrams, block diagrams and descriptions of the systems and equipment used for gas supply, circulation, purification and conditioning of the atmosphere in the pressure hull, including the monitoring equipment, for both normal and emergency operation.
2. Mathematical proof of the adequate capacity of the breathing gas supply and air renewal systems under normal and emergency conditions.
3. Description of the facilities for supplying water, food and medicines and for evacuating waste.
4. In the case of externally supplied submersibles, drawings and descriptions of the umbilical are to be submitted.

213. Fire protection and fire extinguishing equipment

For the fire protection and fire extinguishing equipment, the following are to be submitted:

1. Description of preventive fire precautions
2. Fire protection plans
3. Details of the nature and quantity of combustible materials in the submersible.
4. Drawings and descriptions of:
 - (1) Fire detectors
 - (2) Fire extinguishers
 - (3) Fire alarms.
5. Analysis of the dangers arising from possible outbreaks of fire.

214. Evacuation systems

Drawings and descriptions are to be submitted of the systems and equipment for evacuating the vehicle crew, passengers and divers.

215. Handling, recovering and mating systems

For the handling, recovering and mating systems, the following are to be submitted:

1. Description of system with details of operating parameters.
2. Installation drawing including control platform arrangement.

3. Design drawings of:
 - (1) Handling devices
 - (2) Mating devices
 - (3) Sub structures of gear and winches.
4. Detailed drawings of interchangeable components and fittings.
5. Drawings of mechanical equipment such as winches, drives etc.
6. Circuit diagrams of the hydraulic and/or pneumatic systems, as applicable.
7. Control diagram and description of safety devices.
8. Details of the ratings and class of protection of electrical equipment.
9. Details of hoisting ropes.

Section 3 Tests and Trials

301. General

1. Submersibles and their ancillary equipment are subject to constructional and acceptance testing. As a minimum requirement, this shall include verification of compliance with the approved documents, inspection of workmanship, verification of materials and the relevant documentation and checking of dimensional tolerances. In addition, all the tests prescribed in the following paragraphs are to be performed and documented, wherever applicable.
2. For series manufactured parts, test procedures other than those prescribed may be agreed with the Society provided that they are recognized as equivalent by the Society.
3. This Society reserves the right to extend the scope of the tests where necessary and also to subject to test those parts for which testing is not expressly prescribed in the Rules.
4. Parts subject to compulsory inspection are to be replaced with tested parts. The same also applies to spare parts.
5. Where submersibles are equipped with a diver's lockout, the components and equipment concerned are also to be subjected to the tests prescribed in **Pt 9, Ch 7 of Rules for the Classification of Steel Ships**.

302. Total system

On completion, the submersible including the necessary ancillary equipment (e.g. handling and retrieval systems) is to be subjected to a functional and acceptance test in accordance with the approved trial programme. This shall include at least the following individual tests:

1. Inspection of assembly (where not already performed during supervision of manufacture)
2. Measurement of weight and buoyancy and checking of stability under normal and emergency conditions
3. Inspection of internal equipment, partition bulk heads with doors, floors and ladders
4. Testing of all safety devices
5. Functional testing of diving and trimming equipment
6. Functional testing of mechanical and electrical equipment
7. Heeling or trimming experiment submerged
8. Testing of emergency release equipment
9. Trial trip on surface with verification of buoyancy
10. Trial trip submerged

11. Testing of handling and retrieval system
12. Functional testing of life support systems
13. Verification of the accuracy of all important instrument readings
14. Insulation test on the electrical equipment

303. Pressure hull

1. On completion of the machining work and any necessary heat treatment, pressure hulls are to be subjected to a hydraulic external pressure test. This test may be performed either on the raw hull in a compression chamber or as part of a submersion test carried out on the completed submersible. The test pressure is to be determined in accordance with **Table 1.5.3** in **Ch 5**. Pressure hull compartments in which an internal over-pressure may occur are to be subjected to a hydraulic internal pressure test at 1.5 times the maximum permissible working pressure. After the pressure tests, the pressure hull is to be examined for leaks, permanent deformations and cracks.
2. Pressure hull penetrations and closing appliances are to be tested for tightness by the application of a negative pressure of at least 0.2 bar.
3. All pressure hull windows are to be subjected to a hydraulic pressure test. The test may be performed after installation together with the pressure hull or individually in a testing device. The test pressure is to be determined in accordance with the above **Par 1**. After the pressure test, windows may exhibit no scratches, cracks or permanent deformation.

304. External structure

A check is to be carried out on the arrangement, mounting and fastening of such equipment items as stairways, gratings, handrails, bitts, masts, navigating lights, towing devices and draught marks. and the external structural components such as anchors, rudders, manipulators etc. are to be subjected to a functional test.

305. Diving, buoyancy and trimming tanks

1. Diving tanks are to be subjected to a tightness test using air at an excess pressure of about 0.2 bar.
2. Regulating and trimming tanks are to be subjected to a hydraulic pressure test at 1.5 times the maximum permissible operating pressure.

306. Pressure vessels and apparatus

1. Pressure vessels are to undergo a hydraulic pressure test at 1.5 times the maximum permissible working pressure before being insulated or painted. The test may result in no leakage or permanent deformation of the vessel walls.
2. Vessels and apparatus which may be subjected to external overpressure equivalent to the maximum permissible diving depth of the submersible are to be subjected to an external pressure test. The test pressure is at least to be equal that applied to the pressure hull.

307. Piping systems, pumps and compressors

1. Pipes

- (1) On completion but before being insulated or painted, all pipes are to undergo a hydraulic pressure test at 1.5 times the maximum permissible working pressure. And after installation on board, all piping systems are to be carried out water tight or leak tests with maximum permissible diving pressure.
- (2) Pipes for breathing gas and oxygen are to be tested for cleanliness.

2. Pumps and compressors

- (1) Pump and compressor components subjected to pressure are to undergo a hydraulic pressure test. For pumps the test pressure shall be 1.5 times the maximum permissible working pressure, for compressors 1.5 times the delivery pressure of the compressor stage concerned.
- (2) On completion, pumps and compressors are to be subjected to a tightness test at their maximum permissible working pressure. In addition, a performance test is to be carried out. With breathing gas compressors, the final moisture content and any possible contamination of the compressed gas are also to be determined. The safety devices are also to be checked.

308. Control systems for depth, trim and positive and negative buoyancy

1. Trimming, freeing and ballast systems are to be subjected to a functional test under normal and emergency operating conditions. The measuring devices as well as the safety and alarm equipment are to be checked.
2. The diving tank venting system and the operating elements are to be subjected to a functional test.

309. Propulsion and manoeuvring equipment

The installation of the propulsion and manoeuvring equipment is to be checked and the entire propulsion plant is to be subjected to a functional test.

310. Electrical equipment

1. Electrical machines, components, including steering and control positions, cables and lines are to be tested in the manufacturer's works in accordance with **Pt 6 of Rules for the Classification of Steel Ships**.
2. All electrical systems and equipment are to be inspected and tested before the submersible is put into service.
3. Electrical protective devices are to be checked; in addition, an insulation test is to be performed on the electrical equipment in the pressure hull.

311. Automation, communications, navigation and locating equipment

1. Indicating and monitoring instruments are to be tested for the accuracy of their readings and their limit value settings.
2. Automatic control systems are to be checked for satisfactory performance under service conditions.
3. Normal and emergency communications equipment is to be subjected to a functional test.
4. Proof is required of the autonomy of the safety systems.

312. Life support systems

1. A functional test is to be carried out to verify the satisfactory functioning of the life support system under normal and emergency conditions.
2. The arrangement of the O₂, CO₂ and H₂ measuring devices is to be inspected, and they are to be checked for the accuracy of their readings and their limit value settings.
3. The sanitary facilities are to be checked to ensure that they are functioning properly.
4. The installation of the ventilation system is to be inspected and the operation of the fans and fire flaps is to be checked.

313. Fire protection

1. The fire behaviour of the internal fittings and equipment is to be checked by reference to the relevant test certificates and symbols, as applicable.
2. A check is to be made as to whether the electrical heating systems and heaters are fitted with

protection against overheating.

3. Fire alarm, detection and extinguishing appliances are to be subjected to a functional test.

314. Evacuation systems

The release equipment is to be subjected to a functional test in shallow water. In the course of this test it shall be proved that the release gear functions properly even with the submersible at the maximum permissible inclination and that adequate stability of the vehicle is maintained after release.

315. Handling, recovering and mating systems

1. After installation on board, the handling and retrieval system is to be loaded with a test load equal to 2.2 times the working load. In addition, a dynamic load test (braking test) is to be carried out at 1.25 times the working load.
2. A test is to be performed to ensure that the mating, release, transfer, lowering and raising of the submersible proceed smoothly and safely under normal and emergency operating conditions.
3. Where a mating device is provided, a test is to be performed to verify that release and transfer can only take place when the trunk is not under pressure.
4. The safety devices are to be checked.

Section 4 Marking

401. Marking

1. All valves, fittings, controls, indicators and warning devices are to be provided with identification plates made of a material which is at least flame retardant. The identifying marks are to be clear and unmistakable (e.g. stating the short designation and/or the function of the item concerned).
2. All pressure vessels and gas bottles are to be prominently and permanently marked with the following details:
 - (1) Name of manufacturer
 - (2) Serial number and year of manufacture
 - (3) Maximum permissible working pressure or diving depth (for compression chambers)
 - (4) Test pressure
 - (5) Capacity
 - (6) Maximum permissible number of divers (for compression chambers)
 - (7) Empty weight (of gas bottles)
 - (8) Date of test and test stamp.
3. Permanently installed gas bottles, gas containers and gas piping systems are, in addition, to be marked with a permanent colour code in accordance with **Table 1.1.1** and with the chemical symbol designating the type of gas concerned. The marking of gas bottles are to be visible from the valve side.

Table 1.1.1 Marking of gas systems

Gas	Chemical symbol	Colour
Oxygen	O ₂	white
Nitrogen	N ₂	gray
Air	–	black
Helium	He	brown
Oxygen/Helium gas mixture	O ₂ /He	white and brown

4. The handling, retrieval and mating appliances are to be fitted with a prominent and permanently mounted name plate containing at least the following information in easily legible characters:
- (1) Name of manufacturer
 - (2) Serial number and year of manufacture
 - (3) Static test load
 - (4) Operational test load
 - (5) Maximum working load
 - (6) Date of test and test stamp. ↓

CHAPTER 2 CLASSIFICATION OF SUBMERSIBLE

Section 1 Classification Registry

101. General

1. Where submersible classed with the Society have satisfactorily undergone the periodical survey, the Certificate of Classification for Submersible is issued or endorsed by this Society and that certificate is to be kept on board ship.
2. The ship is required to carry a submersible log book in which are entered detailed operations repairs etc. The log book is to be submitted to the surveyor on request.
3. Submersible which are not to be classified by this Society but which are constructed in accordance with this Rule and under survey of this Society may be issued an appropriate certificate from this Society.

102. Class notations

The class notations assigned to the submersible classed with the Society are to be in accordance with the **Pt 1, Ch 1, Sec 2 of Rules for the Classification of Steel Ships**.

103. Maintenance of registration

1. Periodical Surveys on installations or equipment registered by the Society to maintain their registration are to comply with the requirements specified by the Society. The application for survey is to be made by the Owners or managers in substitute for the Owners.
2. If a diving system has suffered damage affecting its class or if such damage may be assumed, it is to be informed to the Society and those are to be surveyed before the systems begin operation

Section 2 Classification Survey during Construction

201. Classification survey during construction

For a submersible requiring classification survey during construction, the construction, materials, scantlings and workmanship of the structure, equipment and machinery are to be examined in detail in order to ascertain that they meet the appropriate requirements of this Rule.

202. Approval of plans

For a submersible requiring classification survey during construction, the plans and documents showing the details of the construction, materials, scantlings and particulars of the hull, equipment and machinery are to be submitted in accordance with as provided separately. The same applies also to the cases of any subsequent modifications to the approved drawings or documents.

203. Machinery installation

Main engine, shafting arrangement, boilers, pressure vessels, electrical equipment, piping arrangements and auxiliary machinery to be installed on a diving system intended for classification are to receive survey during construction. Shop trials are to be carried out on completion under the same condition as installed on diving system or a similar condition as far as practicable. Various tests on any special part amongst the automatic or remote control systems and measuring devices considered necessary by the Society may be requested at the manufacturing sites.

204. Workmanship

For classification survey of a submersible, the materials, workmanship and arrangements are to be surveyed under the supervision of the Society's Surveyor from the commencement of the work until the completion of the submersible. When the machinery is constructed under classification survey, this survey is related to the period from the commencement of the work until the final test under working conditions. Any item found not to be in accordance with the Rules or the approved plans, or any material, workmanship or arrangement found to be unsatisfactory are to be rectified.

205. Test

In the Classification Survey during Construction, hydrostatic, watertight and performance tests are to be carried out in accordance with the relevant part of the Rules. Also the control systems and measuring device after installation are to receive the necessary tests as deemed necessary by the Society.

Section 3 Classification Survey after Construction

301. Classification survey after construction

In the Classification Survey after Construction, the actual scantlings of main parts of the diving systems are to be measured in addition to such examinations of the construction, materials, workmanship and actual conditions of structure, machinery, outfitings, and equipment.

302. Submission of plans

In the Classification Survey after Construction, plans and documents as may be required for Classification Survey during Construction are to be submitted. If plans cannot be obtained, facilities are to be given for the Society's surveyor to take the necessary informations from the diving system.

303. Classification survey of submersibles classed by other classes

When a submersible classed with any of IACS Member Societies is intended for classification, plans and documents to be submitted and survey status, etc., are to be complied with as provided separately.

304. Tests

In the Classification Survey after Construction, the hydraulic pressure tests, watertight tests and performance tests are to be carried out in accordance with the requirements of the Rules. However, these tests may be dispensed with, provided that sufficient data on the previous tests are available.

↓

CHAPTER 3 PERIODICAL AND OTHER SURVEY

Section 1 Kinds of Surveys

101. Intermediate Survey

Intermediate Surveys are to be carried out within 3 months before or after the anniversary due date from the completion date of the initial classification survey or of the previous Special Survey.

102. Special Survey.

Special Surveys are to be carried out at a date not exceeding 5 years from the completion date of classification survey or the due date of the previous Special Survey. However, if Special Surveys are carried out at a date which shall be more than 3 months earlier than the due date of Special Survey, the next Special Survey shall be assigned at the date of 5 years after the completion date of the concerned Special Survey.

103. Occasional Survey

All classed submersibles are to be subjected to Occasional Surveys when they fall under either of the following conditions at the periods other than those of Special, Intermediate Survey:

- (1) For the surface dependent submersible, when the support ship or station is changed
- (2) When main parts of submersibles, or important fittings or equipment which have been surveyed by the Society, have been damaged, or are about to be repaired or altered.
- (3) When the all or some parts of machinery is changed or moved.
- (4) When propeller shaft drawn out and the survey of the shaft is requested by the Owner.
- (5) When safety valves are opened up or when settings of safety valves are altered.
- (6) Other cases where surveys are designated or whenever survey is deemed necessary by the Surveyor.
- (7) When due date of survey are to be postponed.

Section 2 Performance of Survey

201. Intermediate Survey

The Intermediate Survey of the submersible is to include at least the following tests and checks:

- (1) Examination of the documents relating to the submersible and scrutiny of the operational records.
- (2) The pressure hull and external structure including all fixtures, penetrations, viewports, doors and covers, seals, locking systems etc. are to be inspected for visible damage, cracks, deformation, corrosion attacks and fouling.
- (3) All other pressure vessels and apparatus, as well as valves, fittings and safety equipment are to be subjected to external inspection.
- (4) The entire machinery installation including the electrical equipment is to be subjected to external inspection.
- (5) Switching from the main to the emergency electricity supply is to be tested.
- (6) Insulation measurements are to be performed on the electrical equipment.
- (7) The accuracy of all important instrument readings is to be checked (e.g. depth gauge, gas analyzer, etc.).
- (8) Wherever appropriate, all emergency and safety systems are to undergo a functional test.
- (9) The handling and retrieval system, if installed, is to be checked for visible damage, cracks, deformations and corrosion attacks and is to undergo a functional test including a brake test (power failure).
- (10) High pressure hoses are to be checked for visible damage and tightness.
- (11) The communication system is to be subjected to a functional test.
- (12) The functional efficiency of the total system is to be checked by means a trial dive.

- (13) Performance of a tightness test on pressure hull penetrations and closing appliances by application of a vacuum of at least 0.2 bar below normal pressure.
- (14) Pressure chambers/diver's lockouts are to undergo a tightness test at maximum permissible operating pressure using air.
- (15) Tightness test on diving tanks using air at a test pressure of approximately 0.2 bar at the completely immersed submersible.
- (16) Tightness test on life support systems and ballast system at maximum permissible pressure.
- (17) Verification of the set pressures of relief valves and of safety and warning systems.
- (18) Functional test on mechanical and electrical equipment.
- (19) Functional test on life support systems.
- (20) Functional test on fire warning and extinguishing systems.
- (21) Functional test on all alarm systems.
- (22) Functional test and purity check on all breathing gas compressors.
- (23) After ten years, all compression chambers and all pressure vessels which cannot be subjected to satisfactory internal inspection are to undergo a hydrostatic internal pressure test.
- (24) Acrylic viewport windows are to be checked. (Maximum service period: to be observed).

202. Special Survey

The following tests and examinations are to be carried out in addition to the items specified in **201**.

- (1) A tightness test is to be performed on the pressure hull at an under pressure of at least 0.8 bar below normal pressure.
- (2) Dimensional checks and non-destructive wall thickness tests are to be performed on the pressure hull and the diver's lockout. Where necessary, buoyancy aids, cladding and layers of thermal insulation are to be removed for this purpose.
- (3) Emergency ballast release and buoyancy tests are to be performed.
- (4) In the case of pressure vessels and apparatus which cannot be satisfactorily inspected internally and those whose satisfactory condition cannot be fully verified by internal inspection, another non-destructive test method is to be used or a hydraulic pressure test is to be additionally performed.
- (5) When deemed necessary by the surveyor, acrylic viewport windows are to be dismantled and examined for cracks.
- (6) The window seatings are to be checked for corrosion attacks.

203. Postponement of Special Survey

If a submersible at the time of the Special Survey is not in a port in which it is to be surveyed or if a submersible is in transit to another port to be surveyed, the due date of Special Survey may be postponed within the period of 3 months at the request of the Owner through the approval of the Society.

204. Damage Survey

1. When the damage causing the affection to safety operation of submersible is occurred, damage survey is to be completed.
2. When the damage is occurred, the extent of the survey will be determined by the Society in each individual case.

205. Commission of Survey

If it is impossible to prepare equipments for internal survey or due to excess cost, those tests at the request of Owners, may be accomplished in other site or company under supervision of surveyors. ↓

CHAPTER 4 DESIGN REQUIREMENTS

Section 1 General

101. General

1. Wherever expedient and feasible, submersibles are to be designed and constructed in such a way that failure of any single component cannot give rise to a dangerous situation.
2. Submersibles and their components are to be designed to meet the service conditions stated in the equipment specification.
3. Submersibles are to be designed and built to ensure safe operation and facilitate proper maintenance and the necessary surveys.
4. Submersibles are to be designed and constructed in such a way that the skipper has an adequate forward view when submerged. The vehicle should be equipped for all round vision when navigating on the surface. This facility can be provided by suitable windows or optical instruments.
5. Submersibles with a diver's lockout are to be designed and constructed to ensure the safe transport and the safe exit and entry of the divers under pressure. In addition, the diver's lockout and any compression chambers provided are to also comply with the **Pt 9, Ch 7 of Rules for the Classification of Steel Ships**.

Section 2 Environmental Conditions

201. General

As a minimum requirement, the design, selection and arrangement of all machinery, instruments and equipment located on board submersibles are required to conform to the environmental conditions stated below. Environmental conditions other than those stated may be approved for submersibles for service only in particular areas.

202. Inclined positions

Satisfactory operation is to be ensured at shaking of 60° , heeling of 30° and trimming of 15° in any direction measured in relation to the as installed datum. Transient inclinations of up to 45 are not to adversely affect operation and not cause damage, particularly to machine mountings.

203. Water

The design of submersibles and components is generally to be based on seawater within the temperature range from - 2°C to +32°C, with a salt content of 35 ppm and a density of 1.028 kg/m³, A value of 0.101 bar/m is to be applied when converting diving depth to pressure.

204. Seaways

Submersibles are to be designed for sea states with a significant wave height of at least 2 m, allowance being made for accelerations of 2 g downwards and 1 g upwards in the vertical and 1 g each in the longitudinal and transverse directions ($m = 9.81 \text{ m/s}^2$).

205. Climate

In all spaces, allowance is to be made for oil and salt-impregnated air ranging in temperature from 0° to 55°C Atmospheric humidity may attain 100 % in the lower temperature range. Condensation is liable to occur. In specially protected control rooms, a relative atmospheric humidity of 80 % at a reference temperature of 40°C is to be assumed. Equipment and instruments are to be continued to function satisfactorily despite fluctuations in the air pressure inside the pressure hull ranging from

0.7 to 1.3 bar. In the diver's lockout and in compression chambers, equipment and instruments should be designed for 1.5 times the maximum permissible working pressure.

206. Vibrations and shaking

Machinery is not to cause any vibration or shaking which imposes unacceptable stresses on other machines, equipment or the hull of the vehicle and it is to be complied with the Rules separately provided by this Society.

Section 3 Hatches, Doors and Access Ports

301. Hatches

1. Submersibles are normally to be equipped with an entry and exit hatch capable of being operated from both sides. The entry/exit hatch is to be designed to allow safe entry into and safe exit from the submersible without water penetrating into the interior of the vehicle.
2. Entry/exit hatches are to be provided with a closing mechanism which enables sufficient pressure to be exerted on the hatch seal even when surfaced. The design of the closing mechanism shall further ensure that the hatch cannot be opened until pressure equalization has taken place.

302. Doors

Provision is to be made to enable doors to be opened from both sides. Door casings are to be provided with pressure equalizing valves.

303. Access ports

Doors and access ports for persons shall have a clear diameter of at least 500 mm. That of diver entry and exit hatches shall be at least 600 mm.

Section 4 Equipment

401. Anchors

Autonomous submersibles are to be equipped with suitable anchors including the necessary hoisting and lowering gear. The anchor gear should be jettisonable in an emergency.

402. Bitts

Submersibles are to be equipped with bitts etc. mooring the vehicle.

403. Lifting and towing attachments

Submersibles operated from support ships are to be provided with lifting and towing attachments enabling the vehicle to be lifted aboard or towed. In addition, such vehicles are to be equipped with alternative lifting attachments to which hoisting gear can be attached in an emergency for retrieving the vehicle.

404. Ramming fenders

Where necessary, submersibles are to be fitted with ramming fenders or similar for the protection of the outer casing.

405. Lights, signal shapes and sound signals

1. Autonomous submersibles are to be equipped with lights, signal shapes and sound signals in accordance with the **1972 International Regulations for the Prevention of Collisions at Sea (COLREGS 1972)**.
2. Non-autonomous submersibles are to be equipped with suitable signalling devices (e.g. flashing lights) enabling the vehicle to be rapidly detected after surfacing.
3. Where the external lighting is installed, it is durable to the maximum permissible diving pressure and is to be watertightness

406. Position indicators, radio direction finders and locating equipment

1. According to their mode of operation and application, submersibles are to be provided with suitable equipment for locating the vehicle when travelling on the surface and submerged.
2. To render them more easily visible when on the surface, submersibles should be painted in contrasting colours or with reflecting media, preference being given to the colours orange, yellow or red.

407. Marker buoy

1. Autonomous submersibles are to be equipped with a marker buoy which can be released from inside the vehicle in an emergency. The marker buoy is to be fitted with an automatic distress signal transmitter.
2. A marker buoy in accordance with **Par 1**. is recommended for non-autonomous submersibles.

408. Other equipment

The equipping of submersibles with, for example, manipulators, TV equipment, searchlights, tools and working gear depends on the type of submersible concerned and its proposed application and is to be agreed with the Society in each individual case.

Section 5 Corrosion Protection

501. General

Submersibles and all their accessories are to be effectively protected against corrosion. Parts of the submersible which are later rendered inaccessible by the design of the vehicle is to be given permanent corrosion protection during construction. Anti-corrosion coatings applied to the interior of submersibles are to meet the requirements of **Pt 9, Ch 7, 704.** of **Rules for the Classification of Steel Ships.** ↴

CHAPTER 5 PRESSURE HULL

Section 1 General

101. General

1. The requirements of this Section apply to pressure hulls of submersibles in which the vehicle crew can be accommodated at atmospheric pressure.
2. The documents to be submitted to the Society for approval are listed in **Ch 1, Sec 2**.
3. The necessary tests and markings are specified in **Ch 1, Sec 3, Sec 4**.

Section 2 Design Principles

201. Internal fittings and equipment of the pressure hull

1. For equipment, fittings, insulation, paintwork and preservative coatings inside pressure hulls, use may only be made of those materials and media which do not release any toxic or severe irritant gases under the atmospheric conditions mentioned in **Ch 4, Sec 2**. Wherever possible, this also applies to the effects of heat.
2. Wherever possible, only non-combustible or at least flame retardant materials and media shall be used inside the pressure hull.
3. Battery spaces are to be so designed that they can accommodate the equipment needed for ventilation, air circulation, acid measurement and cooling.
4. Tanks and bunkers located within the pressure hull are to be functionally designed and provided with sufficient ventilation and drainage facilities in each case. All tanks and bunkers are to be provided with manholes.

202. Allocation of space

As far as possible, the space occupied by the crew is to be separated from that in which machinery and equipment is installed and is to be acoustically and thermally insulated. However, it may not be applied when considered appropriately by the Society as provided separately.

203. Equipment

1. At least one seating facility is to be provided for each crew member.
2. In autonomous submersibles and those designed for periods of service exceeding 12 hours, the pressure hull is to be provided with a suitable accommodation area with sleeping facilities and separate sanitary arrangements.

204. Lighting

Each pressure hull compartment is to be adequately lighted. When the one circuit of lighting is unavailable, the pressure hull compartment is to be adequately lighted by the other circuit of lighting.

205. Miscellaneous

1. Wherever necessary, viewports are to be internally and externally protected against mechanical damage.
2. Pressure hulls are to be adequately provided with eye plates, welding lugs etc. for the attachment of supports.

Section 3 Materials and Weldings

301. General

1. Materials are to be suitable for the purpose intended and for the processes applied, e.g. welding, and are to meet the requirements stated below. Materials for which no special requirements are stated in this section are subject to recognized standards.
2. The manufacturing, processing and testing of materials are to be in accordance with **Pt 2 of Rules for the Classification of Steel Ships**.

302. Approved materials

1. Rolled or forged steels and steel castings with guaranteed ductility and toughness are normally to be used for pressure hull fabrication. Steel plates, profiles and bars are to be made of fine grained special steels which comply with **303.** and conform to recognized standards or manufacturer's specifications which have been examined and approved by the Society. Approved materials for pressure hulls are listed in **Table 1.5.1**

Table 1.5.1 Approved materials for pressure hulls

Type	Grade of materials	Material standards or specification
Plate	Special fine grained steel and rolled steel plates of grade DH 32/36, or EH 32/36	Manufacturer's specification Pt 2, Ch 1, 301. of Rules for the Classification of Steel Ships or Recognized standard
Profiles and bars	General purpose shipbuilding and structural steels, provided these are killed, also fine grained structural steels	Pt 2, Ch 1, 301. of Rules for the Classification of Steel Ships or Recognized standard
Pipes	Seamless and welded ferritic steel pipes	Pt 2, Ch 1, Sec 4 of Rules for the Classification of Steel Ships or Recognized standard
Forgings	Forgings for boilers, tanks and pipings	Pt 2, Ch 1, Sec 6 of Rules for the Classification of Steel Ships or Recognized standard
Castings	Castings for boilers, pressure vessels and pipings	Pt 2, Ch 1, Sec 5 of Rules for the Classification of Steel Ships or Recognized standard
Bolts and nuts	Unalloyed and alloyed steel bar	Recognized standard
View-ports	Acrylic and other approved materials	Separately provided Guidances

2. Materials other than those mentioned in **Par 1**, e.g. austenitic stainless steels, may be used provided they have been proved to be suitable for the intended application. If no recognized standards are available, the relevant specifications are to be submitted to the Society for examination and approval. The use of brittle materials such as grey cast iron is not permitted.
3. Viewports constituting part of the pressure hull are to be made of acrylic plastic and are to meet the requirements separately provided by the Society.

303. Special requirements applicable to materials for pressure hulls

1. Ductility

All metals are to possess sufficient ductility (in terms of the elongation measured by tensile test).

The elongation at fracture is to conform to the values stated in the standard or material specification and shall not be less than 16 %.

2. Impact energy

Steel grades are to conform to the impact energy values measured by notched bar impact test stated in the standard or material specification. In addition, plates are to possess an impact energy of at least 30 J measured on ISO V-notch transverse specimens at a test temperature corresponding to the plate thickness in accordance with **Table 1.5.2** Steel profiles and bars welded direct to the pressure hull, e.g. reinforcing rings or stiffeners, are to possess an impact energy of at least 27 J measured in ISO V-notch longitudinal specimens at a test temperature of 0°C

Table 1.5.2 Test temperature for notched bar

Thickness (mm)	Test Temp (°C)
20 or less	0
21 ~ 40	-20
41 ~ 60	-40
Exceeding 60	by agreement with the Society

3. Freedom from defects

Internal or surface deflections regarded to harmful for usage are not permitted.

4. Proof of characteristics

Proof of the characteristics of materials used for pressure hulls is to be supplied in the form of materials test certificates according to recognized standard. The type of certificate required for the product concerned is to be submitted to the Society and approved.

Section 4 Principles of Manufacture and Construction

401. Treatment

1. Treatments applied to materials are to be properly carried out. Materials whose characteristics have been impaired by hot or cold forming are to be suitably heat treated.
2. Materials are to be so marked as to enable them to be identified and correlated with their respective test certificates even during and after the fabrication of the pressure hull.
3. The requirements separately provided are to be complied with in the manufacture and machining of acrylic windows.
4. The pressure hull is to be exhibit no compression against 1.5 times the maximum permissible working pressure

402. Welding

1. Companies wishing to undertake the fabrication of pressure hulls for submersibles are to have been approved by the Society with regard to their facilities, welding personnel and professional supervision.
2. Before welding work is commenced, the properties of the joints to be welded are to be proved by welding procedure qualification tests at the manufacturer's works.
3. All butt welds in the pressure hull are to be performed as full penetration, multipass welds executed from both sides. In addition, the work is to be performed in such a way that it can be assigned a weld factor V of 1.0.

403. Cutouts and viewports

1. Cutouts causing a weakening of the pressure hull are to be suitably strengthened. The reinforcement is to form an integral part of the pressure hull or connecting piece. Set on reinforcing rings are not permitted. Openings and cutouts, e.g. pipe, cable and mechanical linkage penetrations in bulkheads and web frames, are to be rounded.
2. In the design and construction of viewport flanges, account is to be taken of the fact that the acrylic windows make no contribution to reinforcing the cutout in the shell of the pressure hull. Where the inside diameter of viewport flanges is greater than 350 mm, more stringent requirements are to be applied to the permissible radial deformation and angular deformation of the window seats, and these are to be agreed with the Society in each case.
3. The window seat in the viewport flange is to be designed to give the window sufficient support at the maximum operating pressure. The seat dimensions for various standard windows are separately provided by the Society.
4. For flat windows having a right angled edge and an O-ring seal, the seat diameter in the viewport flange shall be within +0.25 – 0.00 mm of the nominal value, or within +0.75 – 0.00 mm where flat gasket seals are used.
5. For spherical windows with a conical bearing surface, the major diameter of the conical seat in the viewport flange shall be within + 0.002 Do / –0.000 mm of the nominal value. The included conical angle of the window seat in the viewport flange shall be within +0.000–0.25 degrees of the nominal value.
6. The surface roughness of the window seat shall not exceed 1.5 mm.
7. The window seat is to be permanently protected against corrosion (e.g. by overlay welding using corrosion resistant filler metals).
8. A soft gasket material can be used for the primary seal of standard windows. This seal is to be sufficiently thick to enable it to absorb a reasonable degree of deformation without experiencing permanent set.
9. In the case of flat windows with a right angled edge, a second seal is required which is bonded to the flange seat with contact cement. The second seal also acts as a supporting gasket for the window and may not be more than 3 mm thick.
10. Sealing ring grooves are not allowed in the window bearing surface or the metal flange seat.
11. Retaining rings are to be able to provide the necessary initial compression of the window seals.
12. When fitting acrylic plastic windows, care is to be taken to ensure that all bearing surfaces are thoroughly cleaned. Where cleaning agents, window seat greases or adhesives for the window seals are used, these are to be tested for compatibility with acrylic plastic prior to use.

404. Ends

The movement of the rims of dished ends shall not be inadmissibly restricted by mechanical restraints of any kind, e.g. retaining plates, stiffeners etc.

405. Pipe connections and flanges

1. The wall thickness of pipe connections are to be so dimensioned that they are fully able to withstand additional external loads. The wall thickness of socket welded pipe connections shall be compatible with the wall thickness of the part into which they are welded. Pipe connections and flanges are to be socket welded in such a way that the weld configuration includes the whole wall thickness of the pressure hull.
2. Pipe connections in accordance with **Pt 5 of Rules for the Classification of Steel Ships** are to be provided for the connection of pipes.

Section 5 Calculations

501. General

1. Pressure hulls, hatches, windows, suspensions etc. are to be calculated in accordance with the relevant Rules of the Society or other code of engineering practice. Pressure hulls and pressure vessels subjected to external overpressure may be calculated in accordance with Guidances separately provided.
2. The calculations on which the design is based are to be submitted to the Society. Where the calculations are to be performed with the aid of computers, proof of the suitability of the programs is to be furnished to the Society.
3. Allowance is to be made for the loads due to nominal diving pressure, test diving pressure, collapse pressure, internal overpressure and any dynamic loads, reaction forces and additional local stresses caused by fastening attachments and supports. The calculations are also to take account of the environmental conditions specified in **Ch 4, Sec 2**.
4. The load factors for dynamic loads are to be agreed with the Society. Account is to be taken of the fatigue strength of the pressure hulls are to be designed for at least 5000 operating cycles.
5. The weld factor of welds is in accordance with **402**.
6. The allowance for corrosion and wear is normally to be 1 mm. The allowance may be dispensed with in the case of plates 30 mm thick, stainless steels or other corrosion resistant materials and where special corrosion protection is applied.
7. The wall thickness of the shells and ends of seamless or welded pressure hulls shall generally not be less than 6 mm.

502. Design criteria

The following design criteria are to be applied to the calculation of components subjected to external over pressure:

- (1) Tensile, compressive and bending stresses at nominal and test diving pressures shall not exceed the permissible values stated in **503**.
- (2) Components critical to stability is to be designed with a sufficient margin to withstand buckling, bulging and lateral buckling at nominal and test diving pressures in conformity with the safety factors stated in **504**. For cylindrical, shells, proof is to be provided of resistance to both asymmetrical and symmetrical buckling.
- (3) The collapse pressure/nominal diving pressure ratio indicated in **Table 1.5.3** are not to be reduced. The possibilities of failure critical to stability and of plastic failure are to be analyzed. Allowance is to be made for the reduction in the modulus of elasticity between the limit of proportionality and the yield point or 0.2 % proof stress. Generally, the material shall be assumed to behave elastically and plastically without strain hardening. Where the compressive load/deformation(P-d) curve for the material has been determined in the presence of the Society's representative, this curve may be used as the basis for calculations.

Table 1.5.3 Test pressure and collapse pressure in relation to nominal diving pressure

Nominal diving pressure P_N (bar)	5 ⁽¹⁾	10	20	30	40	50	≥ 60
Test pressure/Nominal diving pressure $S_1 = P_P/P_N$ ⁽³⁾	1.70	1.40	1.25	1.20	1.20	1.20	1.20
Collapse pressure/Nominal diving pressure $S_2 = P_Z/P_N$ ⁽⁴⁾	3.20	2.40	2.00	1.87 ⁽²⁾	1.80 ⁽²⁾	1.76 ⁽²⁾	1.73 ⁽²⁾
<p>(1) Minimum nominal diving pressure : 5 bar (2) Minimum value $S_2 = 2$ operating depth > Nominal diving depth (3) In the range $P_N = 5^\circ \dots 30$, $S_1 = \frac{3}{P_N} + 1.1$ (4) In the range $P_N = 5^\circ \dots 60$, $S_2 = \frac{8}{P_N} + 1.6$</p>							

503. Permissible stresses

The smaller of the following two values is applicable:

$$\frac{R_{m20^\circ}}{A} \quad \text{or} \quad \frac{R_{EH^\circ}}{B}$$

where

R_{m20° = guaranteed minimum tensile strength [N/mm²] at room temperature (may be disregarded in the case of established finegrained steels with $R_{EH} \leq 360$ N/mm² or where external material. overpressure exerts a compressive load)

R_{EH° = guaranteed yield point or minimum value of 0.2 % proof stress at design temperature

The safety factors A and B are shown in **Table 1.4.5**.

Table 1.5.4 Safety factor

Material	Nominal diving pressure		Test diving pressure		Collapse pressure	
	A	B	A'	B'	A''	B''
Ferritic material	2.7	1.7	-	1.1	-	1
Austenitic material	2.7	1.7	-	1.1	-	1
Alluminium	4.0	-	2.6	-	1.5	-

504. Safety factors against buckling and tripping

1. Cylindrical shells are to be designed to withstand elastic buckling and stiffening rings to resist tripping at nominal diving pressure by the application of a safety factor S_k of at least 3.0 (under test $S'_k = 2.2$).
2. Dished ends are to be designed with at least the safety factor S_k or S'_k to be calculated according to the following formulae taking into account the wall thickness S and the reference radius R of the connected cylindrical shell:

$$S_k = 3 + 0.002 \frac{R}{S}$$

$$S'_k = \frac{2.2}{3} S_k$$

505. Allowance for manufacturing tolerances

If the manufacturing tolerances on which calculations have been based are exceeded, the deviations observed are to be used to carry out a mathematical verification of the maximum permissible pressure. ↴

CHAPTER 6 EXTERNAL STRUCTURE

Section 1 General

101. General

1. The requirements of this Chapter apply to the entire free flooding external structure of the submersible including cladding, supporting structures and pressure hull fixtures.
2. The documents to be submitted to this Society for approval are listed in **Ch 1, Sec 2**.
3. The necessary tests and markings are specified in **Ch 1, Sec 3** and **Sec 4**.

102. Design Principles

1. All free flooding parts of submersibles are to be designed and provided with openings in such a way that the spaces concerned can be fully flooded and vented.
2. When welding pressure hull fixtures such as diving tank mountings, operating equipment, stabilizing fins, rudders etc., care is to be taken to minimize the resulting internal stresses in the pressure hull. It is to be possible to inspect and preserve even those areas of the pressure hull adjoining fixtures.
3. The external structure of a submersible is to be so designed that parts of it can be crushed without damaging the pressure hull, and in addition steps shall be taken to exclude any likelihood of the vehicle being caught up by parts of its external structure. Anchors are to be so arranged that, when stowed, they are flush with the pressure hull.
4. Manipulators, claws, anchors and other items of gear which may be used to keep the submerged vehicle in position are to be so designed that they can be released or jettisoned in an emergency. Umbilicals and tow lines shall also be jettisonable. Release gear is to be operable even if the main power source fails. It is also to be designed to preclude accidental release or jettisoning. Jettisoning shall not cause any inadmissible heeling or trim conditions.
5. Submersibles with a diver's lockout are to be fitted with supports or runners which ensure a sufficient clearance between the bed and the vehicle.
6. Wherever possible, pressure hull wall penetrations for umbilicals and other pipes, hoses and cables are to be protected against mechanical damage by pressure hull fixtures or cladding.
7. Buoyancy appliances mounted externally on the vehicle are to be properly secured and protected.
8. The lifting point of the submersible is to be so designed and located that the vehicle can be hoisted and retrieved under the maximum permissible seaway conditions. The alternative lifting points are to be so designed and located that the submersible can be raised to the surface despite partial internal flooding.
9. The towing point is to be so designed and located that the submersible can be towed at the maximum towing speed even under the most adverse operating conditions.
10. The external structure of submersibles is to be so designed and, where necessary fitted with gratings, to facilitate safe access to the vehicle.

103. Materials

1. Materials are to be suitable for the intended application and manufacturing process, and are to have been approved by the Society.
2. The manufacture, processing and testing of steels are to be in accordance with **Pt 2 of Rules for the Classification of Steel Ships**.
3. All other materials are to be manufactured and processed in accordance with recognized standards or to material manufacturer's specifications which have been examined and approved by the Society.

4. Materials for rigid buoyancy tanks are to be suitable for the proposed pressure and temperature ranges, are to have a low absorption factor and shall not suffer appreciable crushing under pressure.
5. Suitable proof is to be furnished of the characteristics of materials, e.g. a manufacturer's certificate.

104. Principles of Manufacture and Construction

1. Materials are to be processed by the correct procedures. Whenever necessary, tests of procedure are to be performed and production specimen produced prior to the start of manufacture.
2. Anchors, anchor chain cables/ropes and mooring ropes/hawsers are to be manufactured and tested in accordance with the Rules.

105. Calculations

1. Recognized mathematical procedures are to be followed in performing calculations relating to components of the external structure. The dimensional design of the external structure shall be such that, at the anticipated loads, the calculated stress is not greater than 0.6 times the yield strength.
2. For safety under collision conditions, an acceleration of 3g should be applied in the longitudinal direction ($g = 9.81 \text{ m/s}^2$). In these circumstances, the external structure should be capable of deforming to absorb the impact energy without damage to the pressure hull. ⚡

CHAPTER 7 DIVING AND BUOYANCY TANKS AND TRIMMING DEVICES

Section 1 General

101. General

1. The following Rules apply to the diving, buoyancy and trimming tanks of submersibles and their associated components.
2. The documents to be submitted to the Society for approval are listed in **Ch 1, Sec 2**.
3. The necessary tests and markings are specified in **Ch 1, Sec 3** and **Sec 4**.

Section 2 Principles of Design and Construction

201. General Principles

1. Diving, buoyancy and trimming tanks are to be so designed and arranged to be stable in any operation.
2. It is to be possible to operate the submersible safely on the surface under the maximum permissible seaway conditions.
3. When submerged, it is to be possible to balance and trim the submersible at any depth less than or equal to its nominal diving depth.
4. The submersible is to at all times be capable of returning safely to the surface.
5. In the event of failure of the buoyancy tank system the submersible is to be capable of surfacing by jettisoning of ballast and/or emergency blowing of the diving tanks and is to float on the surface in an upright stable position.

202. Diving tanks

1. Diving tanks are to be designed and fabricated to withstand the impact of waves and their own internal static pressure.
2. Diving tanks are to be provided with vents enabling them to be completely flooded with water. The venting system is to be provided with a separate shut off device for each individual tank. The vent valves are to be designed such as to prevent unintentional opening.
3. Where diving tanks have flooding holes without means of closure, double shut off devices may be stipulated for the vent pipe.
4. Where diving tanks are evacuated by compressed air, it is necessary to ensure that blowing the tanks cannot cause an excessive overpressure.
5. Where the diving tanks are to be pumped out, the flooding holes are to be fitted with means of closure and steps shall be taken to ensure that the freeing of the tanks cannot cause an excessive under pressure.

203. Buoyancy tanks

1. Buoyancy tanks are to be designed for a working pressure corresponding to 1.2 times the nominal diving pressure subject to a minimum of $P_N + 2\text{bar}$. The buoyancy tanks are to be safeguarded against excessive over and under pressures.
2. Buoyancy tanks located within the pressure hull may be designed as gravity tanks provided that

freeing is effected by pumps only.

3. The capacity of buoyancy tanks is to be sufficient to compensate for all the changes in buoyancy expected to arise during the planned diving duties plus a reserve capacity of at least 10 %.
4. Buoyancy tanks may be freed by compressed air or by pumping. The quantity of water admitted during flooding and expelled during freeing must be indicated. For that purpose buoyancy tanks are to be fitted with contents gauges giving a continuous reading.
5. The vent pipes of buoyancy tanks are to be designed and arranged in such a way that water cannot penetrate inside the vehicle unnoticed.

204. Trimming devices

1. To achieve maximum leverage, trimming tanks are to be located as far forward and aft on the vehicle as possible.
2. The transfer of water may be effected by pumping or by compressed air. An automatic control device shall ensure that the transfer always takes place in the desired direction. The quantities of water used for trimming are to be indicated.
3. Trimming tanks which are located inside the pressure hull and which are freed by pumping may be designed as gravity tanks. If the trimming tanks are freed by compressed air, they are to be designed as pressure vessels according to the pressure of the compressed air system. Trimming tanks located on the outside of the submersible are to be designed to withstand an external pressure equivalent to 1.2 times the nominal diving depth.
4. If longitudinally movable weights are provided for trimming, steps are to be taken to ensure that the weights can not accidentally slip out of position.

Section 3 Materials, Manufacture and Calculations

301. Diving tanks

Wherever applicable, the materials, manufacture, design and calculation of diving tanks are to comply with **Ch 5, Sec 5**.

302. Buoyancy tanks, trimming tanks

The materials, manufacture, design and calculation of buoyancy tanks and trimming tanks are to comply with **Ch 5, Sec 5**. ↴

CHAPTER 8 PRESSURE VESSELS AND APPARATUS

Section 1 General

101. General

1. The documents to be submitted to the Society for approval are listed in **Ch 1, Sec 2**.
2. The necessary tests and markings are specified in **Ch 1, Sec 3** and **Sec 4**.

Section 2 Compression Chambers and Diving Bells

201. Compression chambers and diving bells

Compression chambers and diving bells in submersibles are to be built and equipped in accordance with **Pt 9, Ch 7** of **Rules for the Classification of Steel Ships**.

Section 3 Pressure Vessels and Apparatus and Gas Bottles

301. Pressure vessels and apparatus and gas bottles

Pressure vessels and apparatus and gas bottles are to comply with the requirements set out in **Pt 5, Ch 5** of **Rules for the Classification of Steel Ships**. ↴

CHAPTER 9 PIPING SYSTEMS, PUMPS AND COMPRESSORS

Section 1 General

101. General

1. The requirements of this Chapter apply to all piping systems, including valves, fittings, pumps and compressors, which are needed to operate the submersible. In addition to this chapter, they are to be complied with **Pt 5 of Rules for the Classification of Steel Ships**.
2. The documents to be submitted to the Society for approval are listed in **Ch 1, Sec 2**.
3. The necessary tests and markings are specified in **Ch 1, Sec 3** and **Sec 4**.

Section 2 Principles of Design and Construction

201. Pipes, valves, fittings and pumps

1. All pipes, valves, fittings and pumps liable to be loaded with the diving pressure are to be designed for the test depth.
2. Pipes which are led through the pressure hull wall are to be fitted with two shutoff devices, one of which is to be located immediately next to the hull wall.
3. Oxygen pipes are not to be routed close to oil pipes.
4. Gas pipes and electric cable conduits are to be routed separately wherever possible.
5. Shutoff devices are to be approved by the Society. Valves and fittings with screw-down covers or spindles are to be safeguarded against accidental unscrewing.
6. Manual shutoff devices are to be closed by turning in the clockwise direction.
7. The open and closed positions of all sea valves and essential shutoff valves are to be clearly indicated.
8. All valves acting as sea connections are to be so designed that the tapered plug opens against the external pressure.
9. Only screw-down valves are permitted in pipes carrying oxygen. Ball valves may, however, be used as emergency shutoff devices.

202. Bilge pumping and ballast equipment

1. Autonomous submersibles are to be equipped with a bilge system capable of freeing all the spaces inside the vehicle from water due to condensation and leakage.
2. To prevent ballast water and seawater from penetrating inside the vehicle through the bilge system, two check valves are to be mounted in front of the freeing connections. One of these check valves is to be placed in the pipe in front of each suction.
3. Where the bilge, seawater and ballast water systems are interconnected, the connecting pipes are to be fitted with valves in such a way that seawater is reliably prevented from penetrating inside the vehicle through the bilge system even in the event of faulty switching of the valves or when the valves are in intermediate positions.
4. Bilge pumps are to be of the self priming type.
5. The bilge and ballast system are to be provided with at least one stand-by pump.
6. Where diving tanks are freed only by pumps, the standby pump is to be connected to the emergency power supply.

203. Compressed air systems

1. Where air is used to blow diving, buoyancy and trimming tanks, the supply of air carried on board shall be sufficient to blow the diving tanks at least 4 times on surface and the buoyancy tanks at least 3 times at the nominal diving depth. In normal operation, the compressed air receivers providing this supply may not be used for other purposes.
2. A compressor should be provided for charging the compressed air receivers.
3. The compressed air supply is to be carried in at least 2 separate tanks or receivers.
4. The compressed air systems are to be fitted with valves in such a way that no unintentional pressure equalization can occur between different systems.
5. Where pressure reducing valves are fitted, provision is to be made for bypassing and disconnecting these in the event of a fault. In addition, a safety valve is to be fitted on the low pressure side of the pressure reducing valve.
6. Compressed air systems are to be equipped with a sufficient number of pressure indicators.
7. Compressed air systems which come into contact with seawater are to be designed accordingly and are to be separated from other systems. In addition, measures are to be taken which as far as possible rule out the possibility of seawater penetrating into the compressed air system.

204. Hydraulic systems

1. All piping belonging to hydraulic systems which are led through the pressure hull and which are necessary to the safety of the vehicle are to be designed for the maximum allowable working pressure of the system. Wherever necessary, allowance is to be made for the possibility of a pressure rise due to the penetration of seawater into the system.
2. Hydraulic systems essential to the safety of the vehicle are to be equipped with at least one power driven pump and one hand operated emergency pump. Autonomous submersibles are to be equipped with two power driven pumps.
3. In individual cases, hydraulic systems not designed for continuous operation may also be equipped with hand operated pumps.
4. All valves and fittings, including hydraulic accumulators, which are fitted in submersibles are to be designed in accordance with **Par 1**. Valves and fittings are to be placed in easily accessible positions.
5. Hydraulic systems are to be fitted with filters to keep hydraulic fluid clean. In addition, provision is to be made for venting and dewatering the system. Hydraulic fluid tanks are to be fitted with level indicators. Wherever necessary, hydraulic systems are to be equipped with means of cooling the hydraulic fluid.
6. Hydraulic lines should not be routed close to oxygen systems.
7. When selecting the hydraulic oil, allowance is to be made not only for the service conditions but also for the temperatures occurring during the commissioning or repair of the submersible.
8. Hydraulic systems are to be equipped with all the indicating devices necessary to the operation of the system.

Section 3 Materials, Manufacture and Calculations

301. Materials, manufacture and calculations

With regard to materials, manufacture and calculations of pipes, valves, fittings and pumps, they are to be in accordance with **Pt 5** of **Rules for the Classification of Steel Ships**. ↓

CHAPTER 10 CONTROL SYSTEMS FOR DEPTH, TRIM, POSITIVE AND NEGATIVE BUOYANCY

Section 1 General

101. General

1. The requirements of this Chapter apply to all equipment for the static control of the depth, trim and positive and negative buoyancy of submersibles.
2. The documents to be submitted to the Society for approval are listed in **Ch 1, Sec 2**.
3. The necessary tests and markings are specified in **Ch 1, Sec 3** and **Sec 4**.

Section 2 Principles of Design and Construction

201. General principles

1. Submersibles are to be fitted with equipment for controlling depth, trim and positive and negative buoyancy. It is necessary to ensure that this equipment functions properly under all the specified conditions of heeling and trim including those liable to occur as the result of an accident.
2. All the operating units for controlling depth, trim and positive and negative buoyancy are to be grouped together and clearly marked, either on the control console or, in autonomous submersibles, at the diving control stand.
3. The control console or the diving control stand, as the case may be, is to be equipped with indicating instruments which show continuously the position of the submersible and the state of the depth, trim and positive and negative buoyancy controls.

202. Systems and components

1. The design and construction of systems and components for the control of depth, trim and positive and negative buoyancy are to comply with **Ch 7** and **Ch 9**.
2. Control operating units and indicating instruments are subject to the Rules set out in **Ch 13**.
3. The dynamic depth control equipment is to be complied with **Ch 11**. ↴

CHAPTER 11 PROPULSION AND MANOEUVRING EQUIPMENT

Section 1 General

101. General

1. The requirements of this Chapter apply to all equipment for the propulsion and dynamic positioning of submersibles and to all steering gears, including dynamic depth control. In addition, propulsion units and steering gears are subject to **Pt 5 of Rules for the Classification of Steel Ships**.
2. The documents to be submitted to the Society for approval are listed in **Ch 1, Sec 2**.
3. The necessary tests and markings are specified in **Ch 1, Sec 3** and **Sec 4**.

Section 2 Principles of Design and Construction

201. Propulsion units

1. With regard to their type, number, size and arrangement, propulsion units are to be designed in accordance with the intended duties of the submersible.
2. Externally mounted propulsion units are either to be designed for the maximum permissible diving pressure of the submersible or they are to be pressure equalized.
3. Propulsion engines for submersibles are to be designed for intermittent and continuous service.
4. When travelling on the surface, the air supply to internal combustion engines shall pass through an air mast. Exhaust lines are to be led out through the pressure hull via a double, pressure-tight shutoff device. The requirements to be met by closed-circuit propulsion systems are to be agreed with this Society in each individual case.
5. Electric propulsion motors are to be designed in accordance with **Pt 6 of Rules for the Classification of Steel Ships**.
6. If the propulsion engine is located inside the pressure hull, the thrust block should also be located in the same space.
7. Shaft penetrations through pressure hull walls should be fitted with a gland of proven type designed to withstand the maximum diving pressure.
8. Where necessary, propellers are to be shielded to avoid endangering divers and to prevent fouling.
9. Devices for controlling the engine speed and/or the direction of rotation are to be so designed that the propulsion engine can be stopped when they fail. The propulsion engines of autonomous submersibles are to also be capable of manual control.
10. The propulsion equipment is to be fitted with a sufficient number of indicators and alarms to guarantee safe operation.

202. Manoeuvring equipment

1. Submersibles are to be equipped with suitable devices to ensure that the vehicle possesses the necessary manoeuvrability both on the surface and when submerged.
2. Horizontal and vertical rudders are to be designed to withstand the maximum loads generated by the pitching motions of the submersible and the wash of the sea when surfaced and by the steering forces experienced when submerged. The effective stress in the rudder stock shall not exceed 0.5 times the yield stress.
3. Autonomous submersibles are to be equipped with at least one main and one auxiliary steering gear. With the vehicle travelling at full speed, the main steering gear is to be capable of putting the

rudder from 35 on one side to 30 on the other within 28 seconds.

4. Horizontal rudders are to be so designed that, over the whole speed range and under all loading conditions, the desired depth can be maintained.
5. Horizontal rudder systems are to be equipped with a second power supply which meets the requirements of preceding **Pars 2.** and **4.** It is to be possible to switch from the main to the alternative power supply from the control stand.
6. The slewing mechanisms of propulsion units which are also used for manoeuvring are subject to the same requirements as rudders.
7. The main and emergency control stands of autonomous submersibles are to be fitted with indicators showing the positions of vertical and horizontal rudders. All other submersibles are to be equipped with at least one position indicator each for the vertical and horizontal rudders. In addition, suitable indicators are to be fitted which signal any malfunction or failure of the steering gear. ↓

CHAPTER 12 ELECTRIC EQUIPMENT

Section 1 General

101. General

1. The requirements of this Chapter is applied in addition to **Pt 6 of Rules for the Classification of Steel Ships**, to all electrical equipment on board submersibles as well as to equipment for the handling and retrieval of submersibles, where appropriate. In submersibles with a diver's lockout, the electrical equipment in the area of the diver's lockout is also required to comply with the provisions of **Pt 9, Ch 7, Sec 12 of Rules for the Classification of Steel Ships**.
2. The documents to be submitted to the Society for approval are listed in **Ch 1, Sec 2**.
3. The necessary tests and markings are specified in **Ch 1, Sec 3** and **Sec 4**.

Section 2 Design Principles

201. General principles

1. All electrical systems and equipment are to be constructed and installed in such a way that they are serviceable and perform satisfactorily under the design conditions specified for the submersible. The operating parameters of electrical equipment are to conform to the requirements stated in **Pt 6 of Rules for the Classification of Steel Ships**.
2. The following items of electrical equipment on submersibles also count as essential consumers:
 - (1) Battery charging equipment
 - (2) Battery room ventilators; Acid circulation and cooling system
 - (3) Equipment for monitoring and treating breathing air.
 - (4) Steering gears

202. Materials and insulation

1. The materials used in the construction of electrical machines, cables and apparatus are to be resistant to moist and salty sea air, seawater and oil vapours. They may not be hygroscopic and are to be flame retardant and self-extinguishing. The requirement that they should be flame retardant does not apply to winding insulations.
2. Materials with high tracking resistance are to be used for the supports of live parts.
3. Leakage paths and air gaps are to be calculated in conformity in accordance with recognized standard. Generator circuit-breakers, pressure hull wall penetrations, under water plug connectors and appliances directly connected to the busbars are to be designed for the next higher nominal insulation rating.
4. Materials and insulations for electrical equipment used in water are to be agreed with the Society in each instance.

203. Supply systems

1. Approved supply systems are:
 - (1) Direct current and single-phase alternating current: 2 conductors insulated from the vehicle hull
 - (2) Three-phase alternating current: 3 conductors insulated from the vehicle hull
2. Networks with an earthed neutral are not permitted in submersibles.

204. Voltages and frequencies

The use of the following standard voltages and frequencies is recommended.

- (1) The maximum permissible voltages are 500 V:
 - (a) for permanently installed power systems
 - (b) for permanently installed control current circuit
 - (c) for power systems connected by socket outlets, provided they do not need to be handled
 - (d) for heating and galley equipment.
- (2) The maximum permissible voltages are 250 V:
 - (a) for lighting systems and sockets for direct current and single-phase alternating current
 - (b) mobile appliances with double insulation and/or protective isolating transformers
 - (c) machinery control and monitoring systems, vehicle, control systems and vehicle safety systems.
- (3) The maximum permissible voltages are 50 V (protective low voltage):
 - (a) for mobile appliances used in confined conditions in damp spaces, upper decks, stores, machinery spaces and similar service spaces, where these appliances are not double insulated and/or fitted with protective isolating transformers.

205. Protective measures

1. All electrical equipment is to be protected in accordance with **Pt 6 of Rules for the Classification of Steel Ships** unless otherwise stated below.
2. The minimum classes of protection stated in **Table 1.12.1** are to be applied in submersibles. The class of protection is to be maintained for the equipment as installed, even when in operation (heeling position). In this context, the provision of shielding at the point of installation is deemed to be a protective measure.

Table 1.12.1 The minimum classes of protection

Type of equip. Where installed	Generators Motors Transformers	Switchgear Electronic units Recording equip.	Telecommunication equipments Input units Signalling equipments Switches, Sockets Junction boxes Actuators	Heating equipment Heaters Cooking equipment	Lighting fittings
Service spaces Control rooms Accommodation rooms Wireless rooms	IP23	IP23	IP23	IP44	IP23
Sanitary spaces Commissary spaces Machinery spaces Separator and pump rooms	IP44	IP44	IP55	IP44	IP34
Pipe tunnels, bilges	IP56	–	IP56	IP56	IP56
Outside pressure hull	Watertightness under pressure in accordance with the submersibles design criteria				

3. Protective conductors

- (1) The following points are to be observed in relation to the use of protective conductors:
 - (a) The protective conductors are to take the form of an additional cable, additional conductor or additional core in the connecting cable; cable shields or sheaths may not be used as protective conductors.
 - (b) A conductor which is live in normal operation may not at the same time be used as a protective conductor and may not be connected with the latter to the hull.
 - (c) The cross-section of the protective conductor is to be equal to at least half that of the principal conductors. However, with cross-sections of 16 mm² and under, its cross-section is to be equal to that of the principal conductors. The minimum cross-section of separately laid protective conductors is 4 mm². In the vehicle's propulsion network, the dimensional design

- of the protective conductors is to be based on the maximum short-circuit currents of the equipment concerned, the maximum break times of the relevant protective elements and a maximum temperature rise of the protective conductor of 90°C
- (d) Machines and appliances mounted on insulated vibration dampers are to be earthed with mobile cables or conductors or braided copper leads.
 - (e) The protective conductor is to be connected to the hull in a position where it can easily be checked.
 - (f) The superstructure or the hull of the vehicle, as the case may be, is to be provided in an easily accessible position with means of connection in the form of a connecting plate with M 12 stud bolts to which protective conductors can be connected without the use of tools when the vehicle is in harbour or in dock.
 - (g) The connection described under (f) also serves as a protective lightning conductor when in dock.

Section 3 Power Supply

301. General

1. All electrical equipment essential for the safety of the submersible and its crew is to be connected to an independent main and emergency power supply system.
2. In the case of surface-dependent submersibles the main power supply may be followed directly from the switchboard of the diving support vessel and/or from the main power source of the diving system.
3. The followings may be used as an independent emergency power source:
 - (1) An electrical generator with its own drive
 - (2) An emergency battery of sufficient capacity
4. The power generating and emergency supply equipment is to be so designed that the voltage and frequency variations allowed by the provisions of **Pt 6, Ch 1, Table 6.1.2 of Rules for the Classification of Steel Ships**.
5. The power requirements of the submersible when at sea are to be determined for both underwater and surface navigation.

302. Main power supply

1. Each submersible equipped with a main power source of sufficient capacity to supply the items of equipment mentioned in **Pt 6, Ch 1, 201. of Rules for the Classification of Steel Ships**. It is to be designed to ensure a sufficient supply of electrical power for the proposed period of service when operation is both independent of and dependent on an outside air supply.
2. The main power source is to consist of at least two mutually independent generator sets or of one generator set and a battery of sufficient capacity. The battery is to be capable of being charged from at least one generator set. Exceptions may be permitted in the case of vehicles with a restricted range of service and/or accompanying support vessels.
3. Generator sets with electrical starting equipment are to be provided with a starter conforming to **Pt 5, Ch 2, 202. 5 of Rules for the Classification of Steel Ships**.

303. Emergency power supply

1. An independent emergency power source is to be provided in all submersibles.
2. The emergency power source is to be capable of supplying the submersible with the energy required in emergencies. All electrical equipment required for surfacing the vessel is to be adequately supplied with power; apart from this, simultaneous supply of electrical power to at least the equipment listed below is to be ensured for the periods specified in **Ch 14, 201.**

- (1) Emergency lighting inside the vehicle
 - (2) Emergency communications equipment
 - (3) Equipment for maintaining a breathable atmosphere
 - (4) Important monitoring and alarm equipment, e.g. leakage monitoring system, fire alarm system, O₂ monitor and H₂ monitor
 - (5) Solenoid valves for blowing diving and reserve buoyancy tanks
 - (6) Stand-by pumps for freeing the diving tanks (where fitted, for freeing the diving tanks 1.5 times at nominal diving depth)
 - (7) Locating equipment, signal lamps.
3. In addition, in autonomous submersibles it is to be possible to supply electricity to the wireless equipment and important navigating equipment for at least 18 hours of operation.

304. Charging and shore connection

1. Where socket connections are provided for charging and shore connection, these are to be so designed that the plugs cannot be inserted or withdrawn on load.
2. The submersible is to be provided with a control switch enabling the supply switch of the shore or charging station to be disconnected.

305. Storage batteries

1. Storage batteries providing a power source for electric propeller drives and/or the vehicle's power network should be accommodated in special battery spaces. It is necessary to ensure that the storage batteries are accessible for cell replacement, for repairs and maintenance.
2. Battery spaces are to be arranged and ventilated to prevent the accumulation of ignitable gas mixtures.
3. The quantity of air to be aspirated and exhausted during charging is to be so calculated, as to exclude any possibility of exceeding the lower explosion limit for a hydrogen air mixture. H₂ monitors permanently mounted at suitable points are to measure the gas concentration in the battery space, the exhaust system and, where necessary, in other spaces within the vehicle. If the gas concentration reaches and exceeds a level equivalent to 35% of the lower explosion limit, this shall automatically release a visual and audible alarm at a central monitoring station. Equipment for monitoring the H₂ concentration is to be type tested.
4. Battery spaces may contain no other electrical appliances apart from the storage batteries themselves and light fixtures with at least T1(Exe T1) class enclosure. Switches, sockets, junction boxes etc. are to be placed outside battery spaces. The installation of battery monitoring equipment, e.g. H₂ monitors with T1 (Exi T1) class enclosure, is permitted. Single-cell fuses for the voltage measuring system are permitted with T1 (Exd IIC T1) type enclosure.
5. Measures are to be taken to ensure that neither the crew nor the operational equipment can be endangered by emissions of electrolyte fumes.
6. A sign is to be mounted at the entrance of battery spaces pointing out that only insulated tools are to be used inside and conductive objects like keys, ballpoint pens, watches with conductive watch straps have to be taken off. Attention is to be drawn to the explosion hazard.
7. Storage batteries are to be installed in such a way that mechanical damage is as far as possible excluded. Safe operation under the environmental conditions stated in **Ch 4, Sec 2.** is to be ensured and the discharge of electrolyte is to be prevented. Suitable measures, e.g. provision of plastic trays or flexible rubber bags, are to be taken to prevent, wherever possible, electrolyte from entering the battery space bilges in the event of mechanical damage to individual battery cells.
8. Where the installed battery capacity is 1000 AH or more, the battery is to be divided into smaller battery units so that restricted operation of the submersible is still possible in the event of a fault.
9. Lead and alkaline storage batteries may not be accommodated in the same space or be placed in direct proximity to each other.
10. The design of storage batteries and battery chargers is complied with **Pt 6 of Rules for the**

Classification of Steel Ships.

11. Battery chargers are to cut out automatically in case of :
- (1) Failure of battery space ventilation
 - (2) Excessive temperature of charging generator.
 - (3) Excessive H₂ concentration.

306. Power distribution

1. Distribution and switchgear

- (1) Electrical distribution systems are to be so designed that a fault or failure in one circuit cannot impair the operation of other circuits or the power supply.
- (2) In normal operation, the emergency power distribution system may be supplied via a transfer line from the main power distribution system.
- (3) Switchboards are to be so placed as to minimize the length of the cables connecting all the storage batteries to the board. These cables are to be laid as far as their respective circuit breakers in separate cable runs and are to be protected against mechanical damage.
- (4) Effective measures are to be taken to prevent the occurrence of vagabond voltages inside switchgear. Circuits at protective low voltage may not be routed with circuits at higher voltage in a joint conductor bundle or cable duct. Terminals for different voltage levels are to be arranged separately and are to be clearly identified.
- (5) Switches and fuses for different voltage systems are to be spatially separated inside the switchboard.

2. Switching and protective devices

- (1) Each circuit is to be protected against overload and short circuit.
- (2) All consumer circuits are to be fitted with switches. The switching action is to be on all poles.
- (3) Fuses may be used for overload protection on submersibles up to a rated current of 63 A.
- (4) A continuously operating insulation monitoring system is to be installed. An alarm is to be tripped at the control platform if the insulation value drops below a preset limit.

3. Enclosures for electrical equipment

- (1) The enclosures of electrical equipment installed outside the pressure hull or operated in water is to be approved by this Society.
- (2) Enclosures mounted on the outside of the pressure hull are to be tested at the test diving pressure, subject to a minimum of 1.3 times the design pressure.

4. Earthing

- (1) Earthing arrangements on surface-dependent submersibles are subject to the requirements in **Pt 6 of Rules for the Classification of Steel Ships**.
- (2) The earthing of electrical systems and equipment on autonomous submersibles is subject to the requirements stated in **Pt 9, Ch 7, 1204.4 of Rules for the Classification of Steel Ships**.

5. Cables and lines

- (1) Cables and lines for submersibles are to be approved by the Society.
- (2) The selection, dimensions and installation of cables and lines shall comply with the **Pt 6 of Rules for the Classification of Steel Ships**.
- (3) Only halogen-free materials should be used as insulating sleeves, protective coverings, sheaths and fillers of cables used in submersibles.
- (4) Underwater cables and lines are to be radially watertight and designed for an external hydrostatic pressure equal to the destructive pressure of the pressure hull. The pressure resistance is to be verified by pressure testing each made up length after the connectors have been fitted.
- (5) Electric umbilicals are to be tested in the manufacturer's works in the presence of the surveyor.
- (6) In cables for winding on drums, no mechanical forces may be transmitted via conductors of the cable and their insulation.

6. Busbars

- (1) Where busbars are used for connecting equipment, only sealed or insulated systems may be employed. Exceptions to this Rule are switchboards and enclosed electrical service spaces.
- (2) The loading of busbars is to conform to the requirements of **Pt 6 of Rules for the Classification**

of Steel Ships. On continuous load, the busbar temperature may not exceed 100°C.

- (3) The busbar system is to be so constructed that neither the connected equipment nor the busbar system itself can be damaged by movement of the busbars, temperature rises or external mechanical influences. It is recommended that expansion links should be fitted. Prior to the installation of busbar systems, proof is of mechanical strength under short-circuit considering the effects of the electrical heating produced by the short-circuit current.
- (4) Only copper with a conductivity of $56 \text{ m}/\Omega\text{mm}^2$ may be used for busbars. If other conducting materials are used, the loading capacity of the system is to be reduced accordingly.

7. Electrical penetrations in pressure hull walls, underwater plug connections

- (1) Pressure hull penetrations are to be gas and watertight. Their tightness is to be guaranteed even should the connected cables be damaged or shorn off. Electrical penetrations may not be used for the passage other systems.
- (2) Electrical pressure hull penetrations and underwater plug connections are to be type tested. Type testing is performed, on application, at the manufacturer's works and comprises at least the following tests:
 - (a) Hydraulic pressure test, in which the test pressure is to equal twice the design pressure. The test is to be conducted in accordance with the test pressure/time curve shown in **Fig. 1.12.1**, the changes in pressure being applied as quickly as possible.

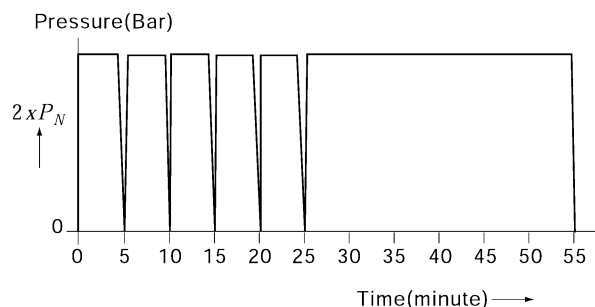

Fig 1.12.1 Test pressure/time curve

- (b) Gastightness test with shorn, open cable ends. This test may be performed alternatively under air or helium pressure. If compressed air is used, the test pressure is to equal twice the design pressure; if helium is used, 1.5 times. In all pressure and tightness tests on pressure hull wall penetrations, the pressure is to in each case be applied from the pressure side of the wall penetration. During the pressure and tightness test, the penetration is to be loaded with the rated current in all conductors.
 - (c) High voltage test at an AC voltage of 1000 V plus twice the rated voltage. This test is performed at the rated frequency and is to be carried out for 1 minute in each case between all the conductors mutually and between the conductors and the casing. The test is performed in the disconnected state. The sealing of the conductors shells and the like is permitted where this is stipulated by the manufacturer in the relevant data sheet.
 - (d) Measurement of insulation resistance. The minimum value of the insulation resistance between the conductors mutually and between the conductors and the casing shall be 5 MW. The insulation resistance is to be measured with an instrument using 500 V DC. With wet plug connections, the minimum insulation resistance is also to be measured after the connection has been made once in saltwater.
 - (e) Visual check against manufacturer's documentation.
- (3) All electrical pressure hull wall penetrations and all plug connections are to be subjected to individual visual inspection by the manufacturer. This inspection comprises the following tests:
 - (a) Hydraulic pressure test in accordance with **Fig. 1.12.2** at 1.5 times the rated pressure.
 - (b) High-voltage test
 - (c) Measurement of insulation resistance
 A manufacturer's test certificate is to be issued covering the inspection.

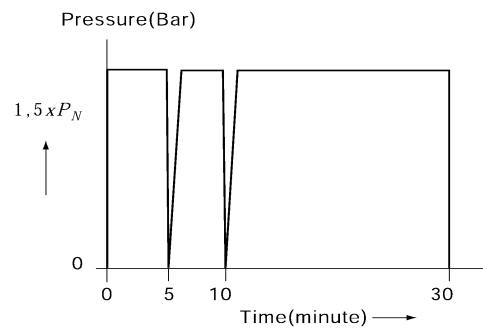

Fig 1.12.2 Test pressure/time curve

307. Electrical machines

1. Electrical machines are to be complied with **Pt 6, Ch 1** of **Rules for the Classification of Steel Ships**.
2. Generators with an output of 100 kVA and all electric propeller motors rated at over 100 kW are to be equipped with a standstill heating system.
3. Machines for electric propeller drives rated at more than 100 kW are to be equipped with monitoring devices in accordance with **Pt 6, Ch 1** of **Rules for the Classification of Steel Ships**.
4. Insulation classes A and E are not permitted the windings of electrical machines in submersibles.
5. In addition to the tests stipulated in **Pt 6, Ch 1** of **Rules for the Classification of Steel Ships** the following electrical machines are to be tested in the presence of the Surveyor:
 - (1) Generators and motors for electric propeller drives
 - (2) Motors for steering gear drives and windlasses
 - (3) All other motors driving machines and equipment necessary to the safety and manoeuvrability of the submersible.

308. Interior lighting

1. Service and work spaces, safety and control stations, accommodation spaces and day rooms are to be equipped with normal and emergency lighting.
2. The lighting is to be so designed and arranged that all important instruments and markings can be read and any necessary operations can be safely performed.

309. Spare parts

1. Autonomous submersibles are to be provided with spare parts in accordance with **Pt 6** of **Rules for the Classification of Steel Ships**.
2. Relaxations can be permitted in the case of submersibles which can only operate in conjunction with, or are supplied by, accompanying surface vessels. ↓

CHAPTER 13 AUTOMATION, COMMUNICATION, NAVIGATING AND LOCATING EQUIPMENT

Section 1 General

101. General

1. The requirements of this Chapter is applied in addition to **Pt 6 of Rules for the Classification of Steel Ships**, to the construction and use of surveillance, control and communications equipment in submersibles as well as to that of wireless, navigating and locating equipment in submersibles built under the survey where appropriate. In submersibles with a diver's lockout, automation, control, monitoring and communications equipment in the area of the diver's lockout is also required to comply with the provisions of **Pt 9, Ch 7 of Rules for the Classification of Steel Ships**.
2. The documents to be submitted to the Society for approval are listed in **Ch 1, Sec 2**.
3. The necessary tests and markings are specified in **Ch 1, Sec 3** and **Sec 4**.

Section 2 Automation Equipment

201. Design principles

1. All equipment for the automatic surveillance and control of submersible operating parameters is to be designed and constructed so that it works properly under the design and environmental conditions specified for the submersible.
2. Computer aided operating systems for the navigation and/or for the surveillance and control of the submersible are allowed. Details of the scope and redundancy requirements of these systems are to be agreed with the Society. The systems are subject to compulsory type testing. Such type testing relates both to the equipment to be used (hardware) and to the corresponding computer programs.
3. The automation equipment on board autonomous submersibles is to be constructed in accordance **Pt 6 of Rules for the Classification of Steel Ships**.
4. All items of surveillance and control equipment are to be clearly inscribed and identified.
5. Indicating instruments and synoptic displays are to be designed and inscribed in such a way that they can be read quickly and clearly.
6. Any fault or failure which may occur in the automation system shall not provoke a critical operating condition.
7. As far as possible, automation equipment is to be safeguarded against faulty operation.
8. Automation equipment is to be capable of maintaining the submersible's assigned operating parameters.
9. Any inadmissible variations in the operating parameters are to actuate an automatic (visual and audible) alarm at the control platform. The same shall also occur in the event of automatic switching operations in the gas and power supply systems or faults in the control and surveillance system.
10. In addition to electronic control and surveillance equipment, independent safety devices are to be fitted which prevent a fault in one system from provoking an improper response in another system.
11. Automatic surveillance and control equipment are to be capable of being switched to manual operation at all times.
12. The response values of automation equipment are to be so coordinated with each other that, when a threshold is reached, a warning is initiated, followed, after a certain warning period or if the process variable continues to change at a preset speed, by the actuation of safety devices.
13. The integral operation of automation systems are to be designed to take account of the lags and

time constants of the units and elements making up the system (e.g. by allowing for the length and cross-section of piping systems and the response time of gas analyzers).

14. The criterion for the freedom from interference of electronic systems is to be in accordance with recognized standard approved by the Society.

202 Construction

1. Electronic automation systems should comprise easily replaceable assemblies, of the plug-in type wherever possible. Standardization of units is to be encouraged and the number of assembly types is to be kept small in order to minimize the spare parts inventory.
2. Plug-in cards are to be clearly marked or coded to prevent inadvertent confusion.
3. Measures are to be taken to prevent condensation inside electronic units, even when switched off. Shutdown heating is recommended.
4. Wherever possible, automation equipment should be capable of operation without forced ventilation. Any cooling system used is to be monitored.
5. Components are to be effectively secured. Any mechanical loading of wires and soldered connections due to vibration or jolting is to be reduced to a minimum.
6. The construction of systems and units is to be simple and straightforward. Good accessibility is to be ensured to facilitate measurements and repairs.

203 Circuitry

1. Signalling equipment and control systems with a safety function are to be designed on the fail safe principle, i.e. faults due to short circuit, earthing or circuit breakers shall not be capable of provoking situations hazardous to personnel and/or the system. In this respect, it is to be assumed that faults occur singly. The failure of one unit, e.g. due to short circuit, shall not result in damage to other units.
2. In stored program control systems, the electrical characteristics of the signal transmitters shall conform to the safety requirements for instruction and control devices.
3. Instruction and control units for safety functions, e.g. emergency stop buttons, shall be independent of stored-program control systems and shall act directly on the output unit, e.g. the STOP solenoid.
4. Stored program control systems are not to be reacted and, in case of fault, should cause no malfunctions in program independent safety inter-locks or stepped safety circuits for fixed subroutines.
5. Freely accessible potentiometers and other units for equipment trimming or operating point settings are to be capable of being locked in the operating position.
6. Interfaces with mechanical switchgear are to be so designed that the operation of the system is not adversely affected by contact chatter.
7. Conductive tracks forming part of circuits which extend outside the enclosure housing the circuit boards is to have qualified short circuit protection. i.e. in case of an external short circuit only the safety devices provided may respond without destroying the conductive tracks.
8. The equipment shall not be damaged by brief overvoltages in the vessel's power supply, due for example to switching operations. The design is to allow for over voltages equal to approximately 2.5 times the rated voltage and lasting 1 ms. Where systems are supplied by static converters, it may be necessary to make allowance for periodic voltage pulses lasting about 0.5 ms. The pulse amplitude depends on the converter type and is to be investigated in each case.

204 Power supply

1. Power supply to the said equipment is to be effected via separate circuits. Selective circuit opening of each of these in the event of short-circuit is to be ensured.
2. The reference conductor system is to be designed to preclude circuit breakers as far as possible.

This may, for example, be archived by duplicating exposed reference conductor joints and connections.

3. The automation equipment is to be capable of being safely operated in the event of voltage and frequency variations referred to in **Pt 6, Ch 2** of **Rules for the Classification of Steel Ships**.

205 Tests

For the automation equipment of novel design, type approval test is to be carried out by the Society. The nature and scope of the type approval test will be determined by the Society in each case.

Section 3 Control System

301. Control platform

1. For the surveillance and control of the submersible a control platform is to be provided which shall be equipped with indicators displaying all essential information about the vehicle, its internal conditions and the operating states of the ancillary systems and with all the regulating and control devices needed to operate the submersible including its wireless, TV and communications equipment.
2. The grouping and arrangement at the control platform of the instruments for the surveillance, control and operation of the submersible shall conform to the principles of safety technology and ergonomics.
3. No units or equipment liable to impede the surveillance or control of the submersible may be installed in the area of the control platform.

302. Control platform equipment

1. For each of the functions to be performed on the control platform of the submersible the following indicating instruments are to be provided as applicable:
 2. **Navigation and speed indicators**
 - (1) Navigational radarscope
 - (2) Position indicator system (GPS, Decca, etc.)
 - (3) Internal communication system, External communication system
 - (4) TV camera
 - (5) Gyro compass
 - (6) Navigating and signal lamp monitor
 - (7) Obstruction signalling device (sonar unit)
 - (8) 2 depth indicators which work independently of each other and are not connected to the same pressure hull penetration. The scales of the depth indicators are to extend at least 20 % beyond the maximum permissible diving depth. The instruments shall give readings accurate to 1 % at maximum diving depth and shall not be significantly affected by pressure variations One depth indicator is sufficient on one-man submersibles attached by hawser
 - (9) Heeling and trim angle indicator
 - (10) Speed and distance indicator
 - (11) Thrust line indicator for propeller drives
 - (12) Steering gear monitor
 - (13) Rudder angle indicators (vertical and horizontal rudders)
 - (14) Indicator showing speed and direction of rotation of main driving propeller
 - (15) Level indicators for reserve-buoyancy and trimming tanks
 - (16) Position indicators for mechanical trimming devices
 - (17) Chronometer. (independent with the vehicle's power supply)

3. Vehicle atmosphere

The indicators and alarms are specified in **Ch 14** for monitoring the vehicle atmosphere.

4. Electrical equipment

- (1) Insulation monitor display
- (2) Battery charging/discharge current
- (3) Battery voltage
- (4) Battery capacity indicator
- (5) Current consumption indicators of propeller motors
- (6) Power supply/distribution indicators

5. Other indicators

- (1) Pressure gauge for all compressed-air receivers
- (2) Pressure gauge for all oxygen storage tanks
- (3) Pressure gauges for hydraulic systems.
- (4) Combined alarms for machinery monitoring systems
- (5) Leakage indicator for all monitored spaces
- (6) Fire alarm display panel (on autonomous submersible)
- (7) Safety and signalling system monitors

303. Control equipment

1. The control platform of the submersible is to be equipped to control at least the following:
 - (1) Pressure, temperature and humidity of the vehicle atmosphere plus the oxygen metering and air renewal rates
 - (2) Operation of propulsion plant
 - (3) Operation of the vertical and horizontal steering gears
 - (4) Blowing of diving and reserve-buoyancy tanks
 - (5) Operation of trimming and ballast systems
 - (6) Operation of freeing systems
 - (7) Operation of electricity supply
 - (8) Operation of ancillary systems, e.g. hydraulic units, manipulators etc.
2. After indication, control function should, wherever possible and expedient, be indicated by synoptic displays on suitable dead-front circuit diagrams on the control console or switchboard.

Section 4 Communication Equipment

401. General

1. Regardless of their type, size and function or range of service, submersibles are to be equipped with various means of internal and external communication.
2. For submersibles with a diver's lockout, the means of communication between the diver in the water and the diver in the lockout and that between the diver's lockout and the submersible's control platform shall meet the requirements set out in **Pt 9, Ch 7 of Rules for the Classification of Steel Ships**.
3. Antennae and transducers are to be permanently installed and so arranged as to preclude mutual interference.

402. Internal communications equipment

1. Submersibles with more than one rest room are to be equipped with a two-way communications system.
2. A telephone link independent of the vehicle's power supply system is to be provided between the control platform and the steering gear compartment and between the control platform and the propelling machinery space.

403. Surface communications

1. Surface independent submersibles are to be equipped with at least one two channel transmitter/receiver, one of the channels of which may operate on safety channel 16-VHF, while the other is used as a “working channel” for communication between the submersible and its support vessel.
2. Autonomous submersibles are also to be equipped with an additional radiotelephone.
3. On surface dependent submersibles, a telephone link is to be provided between the submersible and the control position on the support vessel. The telephone link may operate through loudspeakers and is to be permanently switched to “Receive” on the support vessel's control console. It is also to be fitted with self-resetting switches for reversing the direction of communication. A telephone connection independent of the power supply network is to be provided in addition to the telephone link referred to above.

404. Underwater communications

1. Surface independent submersibles are to be equipped with at least one single channel side band underwater telephone (UT) system. The UT system is to as a minimum requirement enable satisfactory communication to be maintained with the support vessel when this is at a distance equivalent to twice the nominal diving depth of the submersible.
2. Autonomous submersibles are to be equipped with a two-channel side-band UT system.
3. Surface dependent submersibles are subject to the requirements of **403. 3.**

405. Emergency communications equipment

1. Autonomous submersibles are to be equipped with radiotelephones connected to the emergency power supply and capable of both surface and under-water operation. The emergency radiotelephone equipment should include at least one VHF transmitter/receiver operating on safety channel 16. The standby UT system should have a minimum range equivalent to twice the nominal diving depth of the submersible.
2. On non-autonomous submersibles, the UT system is to be fed from the emergency power supply and is to also be capable of acting as standby telephone system when the vehicle is on the surface.

Section 5 Navigating and Locating Equipment

501. General

1. All electrically operated items of navigating and locating equipment necessary to the safety of the submersible and its crew are to be connected to the submersible's emergency power supply. The availability of the equipment for service and its current operating status are to be indicated at the control platform.
2. Wherever necessary, the official national regulations of the home country are to be observed when fitting out the submersible with navigating and locating equipment. The minimum equipment to be provided should include the relevant items specified in **Ch 4, Sec 4** and **Ch 16, Sec 2.** ↓

CHAPTER 14 LIFE SUPPORT SYSTEMS

Section 1 General

101. General

1. The requirements of this Chapter apply to all those plant components and parts which are needed to ensure life support and a safe environment for the occupants of a submersible.
2. The documents to be submitted to the Society for approval are listed in **Ch 1, Sec 2**.
3. The necessary tests and markings are specified in **Ch 1, Sec 3** and **Sec 4**.

Section 2 Design Principles

201. Design and construction

1. Manned submersibles are to be fitted with equipment for producing, maintaining and monitoring life support conditions inside the vehicle. The equipment is to be so designed that the necessary conditions can be maintained for the following times in excess of the maximum intended duty period of the submersible:
 - (1) One man submersibles 72 h
 - (2) Small submersibles 96 h
 - (3) Autonomous submersibles 168 hFor submersibles equipped with a diver's lockout, the area of the lockout and any compression chambers provided are to comply with the requirements set out in **Pt 9, Ch 7 of Rules for the Classification of Steel Ships**.
2. Equipment is to be installed for the circulation and treatment of the atmosphere in the submersible such that the oxygen partial pressure can be maintained within the range 0.19 ~ 0.24 bar and the CO₂ partial pressure can be kept below 0.01 bar in the various spaces. In addition, air purifying and conditioning units are to be installed. The limit values for the permissible atmospheric impurities are to be agreed with the Society in each case.
3. Facilities are to be provided for supplying the whole crew with food and water and for disposing of waste and effluent during the periods stated in the above **Par 1**.
4. An emergency respirator or a breathing mask which can be connected to an emergency breathing air system is to be provided for each crew member.
5. Suitable equipment is to be fitted for monitoring the environmental conditions inside the vehicle. The crew is to be warned by an automatic alarm in the event of inadmissible deviations from the O₂ and CO₂ partial pressures stated in the above **Par 2**.

Section 3 Air Supply

301. Air supply and exhaust system

1. When travelling on the surface, the vehicle is to be ventilated via an air mast which is to be designed and arranged to prevent the penetration of spray and swell water.
2. A power driven extractor fan is to be provided for expelling the battery gases and spent air from the vehicle. The venting of battery spaces is to be separated from other ventilation systems.

302. Oxygen removal

1. An oxygen system is to be installed to replace the oxygen consumed from the atmosphere in the vehicle.
2. The oxygen system is to be designed on the basis of a consumption rate of at least 26 ℓ/h per person.
3. The oxygen is to be stored in at least two separate banks of bottles, if possible, outside the pressure hull.
4. Each bank of oxygen bottles is to be connected to the inside of the vehicle by a separate line.
5. All pipes and components used in oxygen systems are to be carefully cleaned and degreased before being put into service.
6. Manually operated oxygen metering systems are to be equipped with a bottle shutoff valve and a device for controlling the flow rate. A flow rate indicator should be fitted.
7. Metering devices are to be equipped with a manually operated bypass.

303. CO₂ absorption

1. For regenerating the breathing air a CO₂ absorption unit is to be provided which shall be capable of keeping the CO₂ partial pressure in the range 0.005 ~ 0.010 bar. In addition, it shall be possible to maintain a CO₂ partial pressure within the vehicle of not more than 0.020 bar at the end of the survival time stated in **201. 1**.
2. The design of the CO₂ absorption unit is to be based on 2 CO₂ production of 22 ℓ/h per person at 20°C and 1 bar.
3. The CO₂ absorption unit is to be fitted with a dust filter of non-combustible material.

304. Emergency breathing air supply

1. Emergency breathing air systems/appliances are to be designed to ensure that in an emergency all crew members have sufficient breathing air while the submersible is rising, or being brought, to the surface, subject to a minimum time of 30 minutes.
2. The emergency breathing air appliances are to be so designed and arranged that in an emergency each crew member can very quickly reach a breathing appliance and can reach the exit from the submersible without first having to remove the breathing appliance.

305. H₂ monitoring

1. The hydrogen content is to be monitored continuously in the battery spaces, the exhaust system and if applicable in other spaces. The position of the measuring points is to be fixed in accordance with the local conditions.
2. If the gas concentration of 35% of the lower explosion limit is exceeded it is to be signalled optically and acoustically to the control stand. If a value of 50% of the lower explosion limit is reached, all charging or discharging processes have to be interrupted automatically. If the H₂ concentration is still rising after the enforced switch-off, e.g. from finish gassing of the batteries, immediately surfacing is to be initiated and forced ventilation is to be applied.
3. The request for immediate surfacing is to be signalled optically and acoustically at the control stand. Acknowledgment of the optical signal is to be possible only after surfacing and after sufficient fresh air has been supplied.
4. The measuring and signalling equipment for monitoring of the H₂ concentration are to be type tested by the Society.
5. The hydrogen measuring system is also to be supplied by emergency power.

Section 4 Monitoring Equipment

401. Monitoring Equipment

1. The control platform of the submersible is to be fitted with indicating instruments for monitoring at least the following environmental conditions inside the vehicle:
 - (1) Pressure
 - (2) Temperature
 - (3) Humidity
 - (4) Oxygen partial pressure
 - (5) CO₂ partial pressure
 - (6) Pressure of connected breathing gas containers/bottles
 - (7) Outlet pressure of pressure reducing valves
2. The readings of the pressure gauges are to be accurate to at least 1 % of the complete indicating range. The use of mercury pressure gauges and thermometers is not permitted.
3. Each space should be provided with facilities for measuring the room temperature and the O₂ and CO₂ partial pressures.
4. A permanent gauge and a standby indicator are to be provided for monitoring both the O₂ and CO₂ partial pressure. Test tubes may be recognized as standby indicators.
5. The system for the analysis of oxygen is to have a minimum indicating accuracy of 0.015 bar oxygen partial pressure.
6. The CO₂ analysis system is to have a minimum indicating accuracy of 0.001 bar CO₂ partial pressure.
7. A system of analysis is to be provided for determining atmospheric impurities such as CO, NO, NO_x and hydrocarbons. Test tubes may be approved for this purpose.

Section 5 Emergency Thermal Protection

501. Emergency Thermal Protection

Submersibles are to be equipped to provide each crew member with sufficient thermal protection even in an emergency of the duration stated in **201. 1.** ↓

CHAPTER 15 FIRE PROTECTION AND FIRE EXTINGUISHING

Section 1 General

101. General

1. The Rules of this Section apply to the fire protection and fire extinguishing systems of submersibles and are to be applied in conjunction with the Rules.
2. The documents to be submitted to the Society for approval are listed in **Ch 1, Sec 2**.
3. The necessary tests and markings are specified in **Ch 1, Sec 3** and **Sec 4**.

Section 2 Structural Fire Protection

201. Structural Fire Protection

1. As far as possible, only non-combustible materials or materials which are at least flame retardant are to be used inside submersibles. All load-bearing components and insulations are to be made of non-combustible materials.
2. Sources of ignition are to be avoided wherever possible. Electrical heating appliances and heaters are to be fitted with protection against overheating.
3. Components and materials are to be selected with a view to minimizing the acquisition of static charges.
4. Where combustible materials are installed in closed cabinets, the latter are to be so designed that effective extinguishing action can be taken from outside.

Section 3 Fire Surveillance

301. Fire detection and alarm systems

1. Submersibles comprising more than one internal space should be equipped with an automatic fire detection system.
2. The fire detection system should actuate visual and audible signals at least at the vehicle's control platform. Fire alarms should be mounted in the individual spaces of the submersible.

302. Fire detection systems

1. Fire detection systems including central fire detection stations, fire detectors and the wiring of the detection loops require the approval of the Society.
2. Fire detection systems are to be so constructed that any fault, e.g. supply failure, short-circuit or wire breakage in the detection loops, or the removal of a detector from its base triggers a visual and audible signal at the central fire detection station.
3. The design and arrangement of fire detection and alarm systems are to conform to the **Pt 6 of Rules for the Classification of Steel Ships**.

Section 4 Fire Extinguishing Systems

401. Fire extinguishing systems

1. Each compartment of the pressure hull is to be equipped with suitable means for extinguishing a fire in the interior by providing for the rapid and efficient distribution of the extinguishing agent to any part of the space.
2. The fire extinguishing systems are to be designed and constructed in such a way that they can safely deal with every conceivable outbreak of fire under the environmental conditions. Actuation of a fire extinguishing system may not cause any unacceptable pressure change in the space concerned.
3. Extinguishing systems include manual extinguishers or permanently installed extinguishing appliances.
4. Wherever possible, manual extinguishers are to be mounted where they are easily accessible. Permanently installed extinguishing systems should only be capable of manual actuation and should, as far as possible, be safeguarded against improper and accidental operation. The systems should be actuated from outside the space to be protected and only after an alarm has been given in the space which has then been vacated by any human occupants.
5. Extinguishing agents with a toxic or narcotic effect are not permitted.
6. Suitable means are to be provided to ensure that in any space the quantity of extinguishing agent ejected does not exceed that required to extinguish the fire. ⚡

CHAPTER 16 RESCUE SYSTEM

Section 1 General

101. General

1. The following Rules apply to all the systems and equipment listed in **Sec. 2** The personal life saving appliances (e.g. life buoys, life jackets, immersion suits (giving thermal protection)) provided for the crew of the submersible are governed by the related regulation in **Korean Ship Safety Act**. However, when necessary deemed by the Society, additional life saving appliances may be requested.
2. The documents to be submitted to the Society for approval are listed in **Ch 1, Sec 2**.
3. The necessary tests and markings are specified in **Ch 1, Sec 3** and **Sec 4**.

Section 2 Design Principles

201. Design principles

1. For the purposes of this Rule, rescue appliances include all systems and equipment for recovering the submersible and rescuing its occupants, including in particular:
 - (1) Emergency gas supply for blowing the diving tanks
 - (2) Jettisonable ballast
 - (3) Marker buoy and recovery line and Mating flange for rescue submersibles
2. The supply of air to be carried on board is specified in **Ch 9, Sec 2**.
3. Mathematical proof is to be furnished that, after release of the hard ballast, the submersible rises safely to the surface and floats there in a stable position. It shall be possible to release the hard ballast even if the electricity supply fails. The devices for jettison of ballast are to be so designed that two mutually independent actions have to be performed to initiate the release operation.
4. The marker buoy of a submersible (cf. also **Ch 4, Sec 4.**) shall, where appropriate, be fitted with a recovery line with which, in an emergency, an emergency salvage line can be fastened to the submersible to enable it to be brought to the surface.
5. Where the submersible is provided with a mating flange for a rescue submersible, the relevant design parameters and calculations are to be agreed with the Society in each case.
6. A device is to be fitted for the automatic blowing of the diving tanks. This shall be actuated automatically unless, at the expiry of a safety interval, a safety switch (dead man's handle) is actuated, or if the maximum permissible diving depth is exceeded. This device is to be automatically rendered unoperational when the diver's lockout is open. ↓

CHAPTER 17 LAUNCH, RECOVERY AND MATING EQUIPMENT

Section 1 General

101. General

1. The following Rules apply to all equipment and systems for the launch and recovery of submersibles as well as to their mating equipment.
2. The documents to be submitted to the Society for approval are listed in **Ch 1, Sec 2**.
3. The necessary tests and markings are specified in **Ch 1, Sec 3** and **Sec 4**.

Section 2 Design Principles

201. Launch and recovery equipment

1. The design of the launch and recovery equipment is to be based on the 'working load' and the 'dead load' as defined in **Sec 5**.
2. The launch and recovery equipment is to be capable of safely launch and recovering the submersible in the seaway conditions stated in **Ch 3, Sec 2**.
3. The launch and recovery equipment should be fitted with devices for reducing the dynamic loads during launch and recovery operations in a seaway.
4. A coupling system is to be provided to enable the submersible to be safely and smoothly couples to, and uncoupled from the launch and recovery system.
5. Devices are to be provided to stabilize the submersible during launch and recovery.
6. In addition to the launch and recovery equipment, an emergency recovery and towing system are to be provided which, in an emergency, enables the submersible to be raised to the surface and towed.
7. Launch and recovery equipment for submersibles with a diver's lockout are to be in addition complied with the requirements set out in **Pt 9, Ch 7, Sec 14** of **Rules for the Classification of Steel Ships**.
8. Unless otherwise specified in the following **202. to 204.** the mechanical equipment of launch and recovery systems for lifting gear is to conform to the **Pt 9** of **Rules for the Classification of Steel Ships** for Lifting Gear.

202. Power supply, mechanical drives

1. The launch and recovery system are to be provided with at least two mutually independent power sources, each of which are to be capable of supplying all the power needed to launch and recover the submersible.
2. The power sources, together with their feed lines and switchgear, are to be so arranged that a failure or burn-out of one system cannot lead to the failure of the standby system.
3. The launch and recovery system is to be equipped with auxiliary drives enabling a launch or recovery manoeuvre which has already been started to be safely concluded, should the winches or hydraulic pumps fail.
4. Launch and recovery systems using an "A" frame are to be equipped with two hydraulic cylinders which are to be so designed and arranged that each is fully capable of performing the launch and recovery operation under load. In addition, they are to be connected to the hydraulic system in such a way that a single fault in the hydraulic system cannot lead to the failure of both hydraulic cylinders.

203 Control equipment

1. Launch and recovery systems are to be fitted with control equipment enabling the system to be operated intermittently with smooth accelerations. In addition, the controls are to be designed and arranged in such a way that the operator has the submersible in view throughout launch and recovery and is fully able to perform all the necessary actions.
2. The controls are to be fitted with blocking devices which ensure that only those commands can be performed simultaneously which do not produce a dangerous or unintended condition.
3. Control systems are to be provided with an EMERGENCY OFF button.
4. Wherever possible, control units are to operate on the fail safe principle.
5. Control units with remote control are to be additionally equipped with a direct control override. In the event of failure or malfunction of the remote control, all operating sequences which have been initiated are to be automatically STOPPED.
6. All control units are to be clearly and permanently marked and are to be adequately illuminated.

204. Mating equipment

1. Where submersibles with a diver's lockout are equipped for mating with a surface compression chamber, the mating devices shall comply with the requirements stated in **Pt 9, Ch 7, Sec 14 of Rules for the Classification of Steel Ships**.
2. Where submersibles are equipped to transfer human beings at atmospheric pressure, the design and construction parameters for the mating devices are to be agreed with the Society

Section 3 Materials

301. Materials

1. The manufacture, processing and testing of steels are to be in accordance with the **"Guidances for the Manufacturing Process and Type Approval"**
2. All other materials are to be manufactured and processed in accordance with recognized standards or manufacturer's specifications which have been checked and approved by this Society.
3. The use of fibre ropes is permitted only in special cases and with the consent of the Society.

Section 4 Principles of Manufacture and Construction

401. Construction

1. Where cranes are used for launch and recovery, measures are to be taken to prevent the uncontrolled turning or slewing of the crane in a seaway. The turning or slewing gear is to be capable of holding the crane in any position. The gear is also to be designed to ensure that all movements are initiated and arrested smoothly.
2. Launch and recovery systems using an "A" frame are to be so designed and constructed that, at full reach and whatever the trim and heeling condition of the ship, the "A" frame is always subject to an outwardly acting moment. They are also to be designed to ensure that any loads occurring during the recovery of the submersible, e.g. a load change resulting in an inwardly acting moment, can be fully absorbed.
3. Launch and recovery systems are to be equipped to prevent excessive torsional forces being exerted on the submersible during recovery (e.g. by the use of non-spin ropes).
4. Measures are to be taken to prevent the submersible from striking against the ship's hull or against

the launch and recovery gear.

5. All interchangeable single components such as blocks, hooks, shackles etc. are to conform to recognized standards and are to be designed for twice the working load.
6. The driving power of the launch and recovery system is to be sufficient to lift 1.5 times the working load. The capacity of the mechanical brake is to be sufficient to hold the test loads.
7. All interchangeable single components are to undergo, before being fitted, a component load test in accordance with the **Pt 9 of Rules for the Classification of Steel Ships** for Lifting Gear.
8. The rupture strength of ropes shall be verified by testing to destruction.

Section 5 Calculations

501. Calculation

1. The 'working load' of the launch and recovery system comprises the weight of the submersible, including its equipment and ballast weights, the total weight of the crew at 75 kg each plus that of the fully equipped divers at 150 kg each. The 'dead load' is the weight of the launch and recovery system.
2. Regardless of the type of launch and recovery system and the size of the working load, the dimensional design of the launch and recovery system is to allow for a working load factor j of 2.7 and a dead load factor F of 1.5. It is assumed here that the use of the system in a seaway will be limited to significant wave heights of 2 m or less. Where it is proposed that launch or recovery operations should be performed in even more unfavourable conditions, previous agreement with this Society is necessary.
3. Calculations are to be based on the assumption that the angle of engagement of the hoisting and lowering strength member may be 12 off perpendicular in any direction.
4. The maximum static tensile stress imposed on steel wire ropes by the working load may not exceed 12.5% of the proven rupture strength of the ropes.
5. Where ropes made of natural or synthetic fibres are used, the maximum static tensile stress imposed by the working load may not exceed 1/10 of the proven rupture strength of the ropes.
6. The stress limits for components are specified in the **Pt 9 of Rules for the Classification of Steel Ships**. ↓

PART 2
REMOTE-OPERATED VEHICLES

CHAPTER 1 REMOTE-OPERATED VEHICLES (ROVs)

The requirements for Remote-operated vehicles (ROVs) are to be applied to the guidelines for the Rules as provided separately by the Society. ↓

PART 3
TOURIST SUBMERSIBLES

CHAPTER 1 TOURIST SUBMERSIBLES

The tourist submersibles intended for transportation of passengers may apply to the requirements provided separately and additionally they are to be complied with the related regulation of **Korean Ship Safety Act.** ↓



2021

Guidance Relating to the Rules for the
Classification of
Underwater Vehicles

APPLICATION OF THE GUIDANCE

This "Guidance relating to the Rules for the Classification of Underwater Vehicles and Diving Systems" (hereafter called as the Guidance) is prepared with the intent of giving guidelines as to the treatment of the various provisions for items required the unified interpretations and items not specified in details in the Rules, and the requirements specified in the Guidance are to be applied, in principle, in addition to the various provisions in the Rules.

As to any technical modifications which can be regarded as equivalent to any requirements in the Guidance, their flexible application will be properly considered.

APPLICATION OF "UNDERWATER VEHICLES"

1. Unless expressly specified otherwise, the requirements in this Guidance apply to ships for which contracts for construction are signed on or after 1 July 2021.
2. The amendments to the Guidance for 2020 version and their effective date are as follows:

Effective Date 1 July 2021 (Contraction date for construction)

PART 1 SUBMERSIBLES

CHAPTER 1 GENERAL

- Section 2 Drawings and Documents**
 - 205. Diving and buoyancy tanks, trimming devices
 - 205. Newly addition

- Annex 3 Stability of Submersibles**
 - Newly addition

CONTENTS

PART 1 SUBMERSIBLES

CHAPTER 1 GENERAL	3
Section 1 General	3
Section 2 Drawings and Documents	3
Section 3 Test and trials	3
CHAPTER 2 CLASSIFICATION OF SUBMERSIBLE	5
Section 1 Classification Registry	5
Section 2 Classification Survey during Construction	5
Section 3 Classification Survey after Construction	5
CHAPTER 4 DESIGN REQUIREMENTS	7
Section 2 Environmental Conditions	7
CHAPTER 5 PRESSURE HULL	9
Section 2 Design Principles	9
Section 3 Materials and Weldings	9
Section 4 Principles of Manufacture and Construction	12
Section 5 Calculations	14
CHAPTER 12 ELECTRIC EQUIPMENT	15
Section 2 Design Principles	15
CHAPTER 13 AUTOMATION, COMMUNICATION, NAVIGATING AND LOCATING EQUIPMENT	17
Section 2 Automation Equipment	17
CHAPTER 16 RESCUE SYSTEM	19
Section 1 General	19

PART 2 REMOTE-OPERATED VEHICLES

CHAPTER 1 REMOTE-OPERATED VEHICLES	23
Section 1 Registry	23
Section 2 Survey during Construction	24
Section 3 Survey after Construction	27
Section 4 Periodical and other surveys	27
Section 5 Documents and Drawings for Approval	28
Section 6 Design and Construction	29

PART 3 TOURIST SUBMERSIBLES

CHAPTER 1 TOURIST SUBMERSIBLES	39
Section 1 General	39
Section 2 Classification Registry	41
Section 3 Periodical and Other Survey	42
Annex 1 Calculation and Pressure Hulls under External Pressure	49
Annex 2 Design and Construction for Submersible with GRP	67
Annex 3 Stability of Submersibles	74

PART 1
SUBMERSIBLES

CHAPTER 1 GENERAL

Section 1 General

101. Application

1. In application to **101. 5** of the Rules, the design and the construction for submersible with GRP shall be complied with **Annex 2** of this guidance.

Section 2 Drawings and Documents (2021)

205. Diving and buoyancy tanks, trimming devices

The mathematical proof described in **205.** of the Rules is to be complied with the requirements in **Annex 3.**

Section 3 Test and trials

301. General

1. In application to **301. 2** of the Rules, "recognized as equivalent by the Society" means the **Guideline for Approval of Manufacturing and Process and Type Approval, Etc.**
2. In application to **301. 3** of the Rules, "where necessary" means the following requirements:
 - (1) When the submersible is constructed by making each compartment or chamber of different materials, and
 - (2) In the case of the above (1), the watertightness scheme to the connecting parts and data to ensure the watertightness, materials used, technical documents of the connecting method and watertightness test. ↓

CHAPTER 2 CLASSIFICATION OF SUBMERSIBLE

Section 1 Classification Registry

103. Maintenance of registration

In application to **103. 1** of the Rules, "the requirements specified by the Society" means **Pt 1, Ch 3, Sec 1** of the Rules.

Section 2 Classification Survey during Construction

202. Approval of plans

In application to **202.** of the Rules, "as provided separately" means **Pt 1, Ch 1, 202. to 215.** of the Rules.

205. Tests

In application to **205.** of the Rules, "tests as deemed necessary by the Society" means the performance test to know the accuracy for control devices and measurements during sea trials

Section 3 Classification Survey after Construction

303. Classification survey of submersibles classed by other classes

In application to **303.** of the Rules, "as provided separately" means as follows, and on the basis of the ship's particular and purpose, if deemed necessary by the Society, the owner shall send out an additional data to the Society

1. Submission of plans and documents

- (1) Two(2) copies for drawings and documents specified in **Pt 1, Ch 1, 202. to 215.** of the Rules.
- (2) Two(2) copies for results of sea trial and equipment performance tests or calculation data.

2. When the drawing and documents related to the above 1 are submitted to the Society, they may be accepted.

3. Notification of appraisal results for drawing and documents, etc.

After the Society appraises the drawings and documents required in the above **1**, the results shall be given to the owner. However, if it is difficult for these data to be appraised, the visual condition of the ship may be applied.

304. Tests

In application to **304.** of the Rules, on the basis of the survey status given from the previous class, it is to be carried out for the survey regarding to the recommendation and overdue items. When unpracticable, it shall be implemented by the instruction from our Head office. For the submersible intended for classification survey after construction, in addition, the following tests and surveys shall be done according to the age.

- (1) For submersible less than 5 years of age, it shall be referred to the requirements of the special survey, however, when referring to the previous survey records, etc., it is found in satisfactory, the some of survey items may be dispensed with.
- (2) For submersible having 5 years of age or over, it shall be referred to the requirements of the special survey. ↓

CHAPTER 4 DESIGN REQUIREMENTS

Section 2 Environmental Conditions

201. General

In application to **201.** of the Rules, "particular areas" means that engaged for the limited voyage and it is required to consult with the Society respectively.

206. Vibrations and shaking

In application to **206.** of the Rules, "the Rules separately provided by the Society" means the instruction of vibrations and noises for ships" or the International Standards in common. ↓

CHAPTER 5 PRESSURE HULL

Section 2 Design Principles

202. Allocation of space

In applying to **202.** of the Rules, "when considered appropriately by the Society as provided separately." means as follows,

- (1) A submersible not carrying a passenger.
- (2) A submersible is designed so that there is no an individual crew compartment to operate it.
- (3) A submersible is constructed so that a crew to operate it may embark exclusively.

Section 3 Materials and Weldings

301. General

In applying to **301. 1** of the Rules, "recognized standards" means the recognized International Standards in common or recognized National Standards.

302. Approved materials

In applying to **302. 3** of the Rules, "the requirements separately provided by the Society" means the following items. And the acrylic plastic viewports(or windows) means windows made of castings, unlaminated polymethyl methacrylate.

1. General

- (1) The design life of a window is a function of its geometry, conversion factor, t/D_i ratio, and service environment. Windows that are expected to only compressive, or very low tensile stresses, have a longer design life than those that are exposed to high tensile stresses. The design life of windows in the first category shall be 20 years, while for the window in the latter category it shall be 10 years. The design life of windows under this standard shall be as follows,
 - (A) The design life of flat disk windows shown in **Fig 1.5.1** shall be 10 years from the date of fabrication.
 - (B) The design life of conical frustum windows shown in **Fig 1.5.2** and meeting the requirements of this Standard shall be 10 years from the date of fabrication for $t/D_i < 0.5$ and 20 years for $t/D_i \geq 0.5$
 - (C) The design life of double beveled disk windows shown in **Fig 1.5.3** and meeting the requirements of this Standard shall be 10 years from the date of fabrication for $t/D_i < 0.5$ and 20 years for $t/D_i \geq 0.5$
 - (D) The design life of spherical sector with conical edge, hyperhemisphere with conical edge, and NEMO-type windows with conical edge penetrations shown in **Fig 1.5.4** and meeting the requirements of this Standard shall be 20 years from the date of fabrication.
 - (E) The design life of spherical sector windows with square edge and hemispherical windows with equatorial flange, shown in **Fig 1.5.5** and meeting the requirements of this Standard, shall be 10 years from the date of fabrication.
 - (F) The design life of cylindrical windows for internal pressure applications shown in **Fig 1.5.6** shall be 10 years from the date of fabrication.
 - (G) The design life of cylindrical windows for external pressure applications shown in **Fig 1.5.6** shall be 20 years from the date of fabrication.
- (2) The viewports(windows) other than **Table 1.5.2** and **1.5.3** shall be complied with the requirements of International Standards, ASME 2.2.7.1
- (3) The permissible temperature range for acrylic plastic viewports(or windows) : $-18^{\circ}\text{C} \sim 66^{\circ}\text{C}$
- (4) Maximum pressure ratio for acrylic plastic viewports(or windows) : 10 bar/sec
- (5) Maximum pressure cycle : 10,000
- (6) Maximum using hours under pressure of acrylic plastic viewports(or windows) : 40,000 hours
- (7) Maximum working pressure for acrylic plastic viewports(or windows) : 1,380 bar

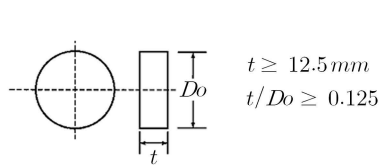

Fig 1.5.1 Flat Disk Viewports

$$t \geq 12.5 \text{ mm}$$

$$t/Do \geq 0.125$$

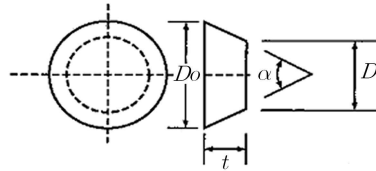

Fig 1.5.2 Conical Frustum Viewports

$$t \geq 12.5 \text{ mm}$$

$$t/Di \geq 0.125$$

$$\alpha \geq 60 \text{ deg}$$

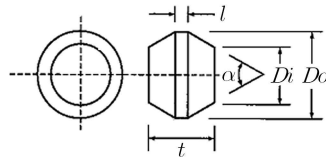

Fig 1.5.3 Double Beveled Disk Viewports

$$t \geq 12.5 \text{ mm}$$

$$t/Di \geq 0.250$$

$$\alpha \geq 60 \text{ deg}$$

$$l \leq 0.25t$$

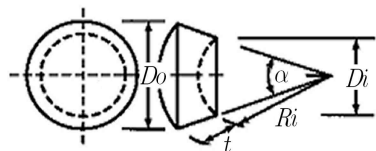

Fig 1.5.4 (a) Spherical Sector Viewports with Conical Edge

$$t \geq 12.5 \text{ mm}$$

$$\alpha \geq 60 \text{ deg}$$

$$t/Ri \geq 0.09 \text{ for } \alpha \geq 60 \text{ deg}$$

$$t/Ri \geq 0.06 \text{ for } \alpha \geq 90 \text{ deg}$$

$$t/Ri \geq 0.03 \text{ for } \alpha = 180 \text{ deg}$$

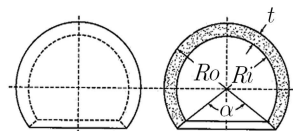

Fig 1.5.4 (b) Hyperhemispherical Viewports

$$t \geq 12.5 \text{ mm}$$

$$0.03 \leq t/Ro \leq 0.355$$

$$\alpha \leq 100 \text{ deg}$$

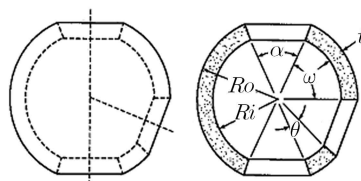

Fig 1.5.4 (c) NEMO Viewports

$$t \geq 12.5 \text{ mm}$$

$$0.03 \leq t/Ro \leq 0.355$$

$$\alpha \leq 60 \text{ deg}$$

$$\omega_i \theta =$$

spacing between adjacent penetrations shall exceed $\alpha/2$ of the larger penetrations

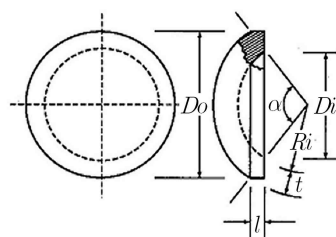

Fig 1.5.5 (a) Spherical Sector Viewports with Square Edge

$$t \geq 12.5 \text{ mm}$$

$$30 \text{ deg} \leq \alpha \leq 150 \text{ deg}$$

$$t/Ri \geq 0.03$$

$$Di = 2Ri \sin \alpha/2$$

$$Do = 2Ro \sin \alpha/2$$

$$Ro = Ri + t$$

$$l = t \sin (90 \text{ deg} - \alpha/2)$$

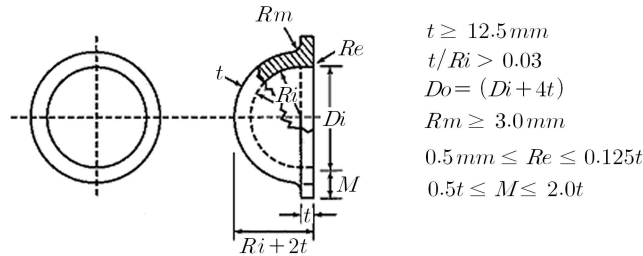

Fig 1.5.5 (b) Hemispherical Viewports with Equatorial Flange

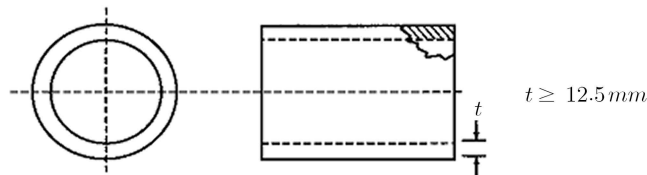

Fig 1.5.6 Cylindrical Viewports

2. Materials

- (1) The materials used for acrylic plastic viewports(or windows) shall be complied with the **Table 1.5.1**.
- (2) The manufacturer, when makes the acrylic plastic viewports(or windows) serially, shall issue the material certificates containing the following requirements.
 - (A) certificate number and dates issued
 - (B) maker's name and address
 - (C) type, design and application for casting
 - (D) a bundle number, quantity, shape and size for casting products
 - (E) marks of castings
 - (F) test results in **Table 1.5.1**
 - (G) endorse or signature
- (3) If there is not the material certificate of acrylic plastic or it is unsatisfied, each test required by the Society shall be done.
- (4) Each casting shall be made by marking at least on the position a manufacturing number, maker's name, dates constructed and a serial number.

3. Construction of viewports(or windows)

- (1) After all viewports(or windows) are constructed by machining required and manufacturer processing, the heat treatment (tempering) shall be done in accordance with maker's specification.
- (2) The viewport's surface shall be polished to be complied with the visual clarity required.
- (3) The maker manufacturing viewports(or windows) shall get the an appropriate certificate about all matters in the process of cutting, joining, polishing, molding and heat treatments, and the certificate shall contain the manufacturing date, performance test and the results.
- (4) At those edge not to be put under the stress, the viewports(or windows) shall be permanently marked with the following items, but not use of punching.
 - (A) a design pressure (bar)
 - (B) a design temperature (°C)
 - (C) an approved stamp by the Society
 - (D) a serial number and a manufactured date

4. Type and size for viewports(or windows)

- (1) Type and size for viewports(or windows) shall be as same as **Table 1.5.2** and **1.5.3**, but for ones other than those viewports(or windows) the date shall be given independently to the Society, and then containing the purpose, the result of the function test and the manufacturing process.
- (2) When constructing the viewports(or windows) the design temperature shall be ready to use the average of maximum inner temperature and outer one.
- (3) When getting a pressure of viewports(or windows) inner and outer, the maximum of them shall

be taken to design.

- (4) In the case of the hemisphere type, the convex part shall be constructed to be pressurized.
- (5) The thickness of the viewports(or windows) shall be equal to all the places, and are requested to comply with the **Table 1.5.2** and **1.5.3**.
- (6) At the surface of viewports(or windows) with conical or convex type, the nominal external spherical radius shall be less than $\pm 0.5\%$ of the difference from ideal spherical sector.
- (7) The surface roughness of viewports(or windows) shall be of 0.75 or less of the value.

Section 4 Principles of Manufacture and Construction

401. Treatment

In application to **401. 3** of the Rules, "the requirements separated provided" means the requirements of **302.** of this guidance.

403. Cutout sand viewports(or windows)

In application to **403. 3** of the Rules, the seat dimensions for various standard windows shall be complied with the requirements of **Table 1.5.1** to **1.5.3**.

Table 1.5.1 Mechanical, Optical Characteristics for acrylic plastic

Characteristics	Limitation	Test method
Ultimate tensile strength Elongation at break Elastic modulus	$\geq 62 \text{ N/mm}^2$ $\geq 2\%$ $\geq 2760 \text{ N/mm}^2$	ASTM D 638 ¹⁾
Compression yield strength Elastic modulus	$\geq 103 \text{ N/mm}^2$ $\geq 2760 \text{ N/mm}^2$	ASTM D 695 ¹⁾
Compressive deformation at 4000 psi(27.6 MPa and 50°C, 24 hours)	$\leq 1\%$	ASME PVHO-1, para 2-3.7 (c)
Ultraviolet transmittance(for 12.5 mm thickness)	$\leq 5\%$	ASME PVHO-1, para 2-3.7 (d)
Visual clarity	Clear print of size 7 lines per column inch(25mm) and 16 characters to the linear inch(25mm) shall ber clearly visible when viewed from a distance of 20 in(500mm) through the thickness of the casting with the opposite face polished	ASME PVHO-1, para 2-3.7 (e)
Total residual monomer Methyl methacrylate Ethyl acrylate	$\leq 1.6\%$	ASME PVHO-1, para 2-3.8
(Remarks) ¹⁾ The mechanical characteristics shall be proved by at least two(2) specimens.		

Table 1.5.2 Standard size for rectangular flat viewports(or windows)

Application Minimum thickness : $t \geq 12.5 \text{ mm}$ Thickness Ratio : $t/D_0 \geq 0.125$ Edge radius : $1 \text{ mm} \leq R_1 \leq 2 \text{ mm}$ Ratio to viewport : $1.25 \leq D_0/D_f \leq 1.5$ Maximum operating pressure : $P \leq 170 \text{ bar}$						
Design Pressure (P_e)(bar)	Minimum thickness / Inner diameter of seat (t/D_i)					
	10°C	24°C	38°C	52°C	66°C	
5	0.134	0.146	0.154	0.164	0.188	
10	0.154	0.173	0.188	0.201	0.226	
15	0.173	0.195	0.210	0.223	0.253	
20	0.188	0.210	0.226	0.240	0.281	
25	0.201	0.223	0.240	0.257	0.305	
30	0.210	0.233	0.253	0.274	0.324	
35	0.219	0.243	0.267	0.292	0.344	
40	0.226	0.253	0.281	0.305	0.363	
45	0.233	0.264	0.295	0.317	0.383	
50	0.240	0.274	0.305	0.329	0.402	
60	0.253	0.295	0.324	0.354	0.441	
70	0.267	0.310	0.344	0.378	0.480	
80	0.281	0.324	0.363	0.402	0.520	
90	0.295	0.339	0.383	0.427	0.559	
100	0.305	0.354	0.402	0.451	0.598	
110	0.315	0.368	0.422	0.476	0.637	
120	0.324	0.383	0.441	0.500	0.676	
130	0.334	0.398	0.461	0.524	0.715	
140	0.344	0.412	0.480	0.549	0.754	
150	0.354	0.427	0.500	0.573	0.793	
160	0.363	0.441	0.520	0.598	0.832	
170	0.373	0.456	0.539	0.622	0.871	

Table 1.5.3 Standards for spherical shell type viewports(or windows) having conical type seat.

Application Opening angle : $\alpha \geq 60^\circ$ Minimum thickness : $t \geq 12.5 \text{ mm}$ Minimum ratio (t/D_0) - when $\alpha \geq 60^\circ$, 0.09 - when $\alpha \geq 90^\circ$, 0.06 Ratio to viewport : $D_i/D_f \geq 1.02$ Maximum operating pressure : $P \leq 170 \text{ bar}$										
Design pressure P_c (bar)	Minimum thickness / inner diameter of seat (t/D_i)									
	when $\alpha = 60^\circ$					when $\alpha = 90^\circ$				
	10°C	24°C	38°C	52°C	66°C	10°C	24°C	38°C	52°C	66°C
5	0.090	0.090	0.090	0.090	0.090	0.042	0.042	0.042	0.042	0.049
10	0.090	0.090	0.090	0.090	0.112	0.042	0.043	0.049	0.054	0.070
15	0.090	0.090	0.097	0.108	0.140	0.043	0.052	0.060	0.067	0.089
20	0.090	0.097	0.112	0.126	0.166	0.049	0.060	0.070	0.080	0.107
25	0.090	0.108	0.126	0.143	0.191	0.054	0.067	0.080	0.091	0.124
30	0.097	0.119	0.140	0.160	0.215	0.060	0.075	0.089	0.102	0.142
35	0.104	0.129	0.153	0.176	0.238	0.065	0.082	0.098	0.113	0.160
40	0.112	0.140	0.166	0.191	0.259	0.070	0.089	0.107	0.124	0.177
45	0.119	0.150	0.179	0.206	0.279	0.075	0.095	0.116	0.135	0.194
50	0.126	0.160	0.191	0.221	0.298	0.080	0.102	0.124	0.146	0.210
60	0.140	0.179	0.215	0.248	0.332	0.089	0.116	0.142	0.168	0.242
70	0.153	0.197	0.238	0.274	0.363	0.098	0.128	0.160	0.190	0.272
80	0.166	0.215	0.259	0.298	0.391	0.107	0.142	0.177	0.210	0.300
90	0.179	0.232	0.279	0.320	0.416	0.116	0.155	0.194	0.230	0.327
100	0.191	0.248	0.298	0.340	0.439	0.124	0.168	0.210	0.250	0.351
110	0.203	0.264	0.315	0.359	0.460	0.133	0.181	0.226	0.269	0.373
120	0.215	0.279	0.332	0.377	0.480	0.142	0.194	0.242	0.287	0.393
130	0.227	0.293	0.348	0.394		0.151	0.206	0.257	0.304	0.411
140	0.238	0.307	0.363	0.410		0.160	0.218	0.272	0.320	
150	0.248	0.320	0.377	0.425		0.168	0.230	0.287	0.336	
160	0.259	0.332	0.391	0.439		0.177	0.242	0.300	0.651	
170	0.269	0.344	0.404	0.452		0.185	0.254	0.314	0.365	

Section 5 Calculations

501. General

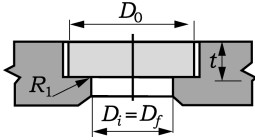
- In application to **501. 1** of the Rules, "the relevant Rules of the Society" means the International Standards in common. And for pressure hulls and pressure vessels subjected to external over-pressure, "guidances separately provided" means the requirement of **Annex 1** of this guidance.
- In application to **501. 4** of the Rules, the load factors for dynamic loads shall be complied with **Annex 1** of the guidance. ⚡

CHAPTER 12 ELECTRIC EQUIPMENT

Section 2 Design Principles

202. Materials and insulation

In application to **202. 3** of the Rules, "recognized standard" means the International Electrotechnical Commission or the International Standards in common. ↓

CHAPTER 13 AUTOMATION, COMMUNICATION, NAVIGATING AND LOCATING EQUIPMENT

Section 2 Automation Equipment

201. Design principles

In application to **201. 14** of the Rules, "recognized standard approved by the Society" means the International Electrotechnical Commission or the International Standards in common.

205. Tests

In application to **205.** of the Rules, "the nature and scope of type approval" means the relevant requirements of **Pt 6, Ch 2 of Rules for the Classification of Steel Ships.** ↓

CHAPTER 16 RESCUE SYSTEM

Section 1 General

101. General

1. In application to **101. 1** of the Rules, "when deemed by the Society" means the following requirements.
 - (1) The submersibles engaged in coastal area or more and carrying passengers without supporting ships.
 - (2) The submersibles engaged in great coastal area or more and carrying the passengers.
 - (3) The submersibles engaged in great coastal area or more and intending for special purpose.
2. In the case of the above **1**, the life saving equipments for crews and passengers (i.e. life buoy, life jackets and Immersion suits and anti-exposure suits shall be of type complied with the requirements of the International Convention, SOLAS. ↓

PART 2
REMOTE-OPERATED VEHICLES

CHAPTER 1 REMOTE-OPERATED VEHICLES

Section 1 Registry

101. General

1. The requirements of this Chapter apply to the unmanned Remote – Operated Vehicles which are permanently installed or installed a limited period as required by the operating condition on ship or similar floating structure.
2. Design differing from this rule of Construction may be permitted provided their suitability has been verified by the Society and they have been recognized as equivalent.
3. ROV's system and parts, thereof whose development is based on new principles and which have not yet been sufficiently tested in practical operation require special approval by the Society.

102. Definition

For the purpose of this Rule, the items used have the meaning designed in the followings unless expressly provided otherwise.

1. Remote-operated Vehicles (ROV's)

Unmanned Vehicle capable of operating under water with remote control.

2. Launch and recovery system

The lifting equipment necessary for raising, lowering and transporting the ROV's

3. Dive Control Station

Control room provided with all the remote control system of the ROV's.

4. Pressure vessel

Vessel subjected to an internal or external working pressure of 1 bar or more.

5. Total system

ROV including its control, launching, recovery, working and supply systems.

6. Maximum diving depth

A maximum diving depth where the ROV's can be operated safety is measured from ROV's bottom to the surface water.

7. Maximum permissible diving pressure

A maximum permissible diving pressure is under maximum diving depth.

8. Umbilical

Kink between the supporting ship and the ROV which can contain monitoring, communications and power supply cables as well as tether

9. Garage

Cage in which the ROV can be launched and recovered, e.g. from the surface vessel, and from which the ROV can travel under water to the work site.

10. Clamping devices

Equipment for securing a ROV, e.g. to a structure.

103. Notations

1. The notation ROV's assigned with the Society are to be in accordance with Pt 1, Ch 1, Sec 2 of

Rules for the Classification of Steel Ships and followings.

+ROV : For ROVs built under the supervision of the Society.

ROV : For ROVs considered to be fit as the result of surveys by the Surveyor after construction

In case of an application of ROVs control station or Launching and recovery system, the notation may be added.

2. When ROV's systems and their parts thereof whose new development is based on other principle, the relevant rules shall be applied.

104. Certification

ROV's which comply with the requirement of the Rules and have been built under the Surveyor to the Society will be issued an appropriate certificate.

105. Maintenance of registration

1. Periodical Surveys on installations or equipment registered by the Society to maintain their registration are to comply with the requirements specified by the Society.
2. If ROV's have suffered damage affecting their class or if such damage may be assumed, they are to be informed to the Society before the systems begin operation.

Section 2 Survey during Construction

201. Survey during Construction

For ROV's systems requiring survey during Construction, the construction, materials, equipment, scantlings, workmanship and performance are to be examined in detail in order to ascertain that they meet the appropriate requirements of the Rules.

202. approval of plans

For ROV's systems requiring survey during Construction, the plans and documents showing the details of the construction, materials, scantlings and particulars of the hull and equipment are to be submitted in accordance with as provided separately. The same applies also to the case of any subsequent modifications to the approved drawings or documents.

203. Workmanship

For classification survey of ROV's systems, the materials, workmanship, arrangements and performances are to be surveyed under the supervision of the Society's Surveyor from the commencement of the work until the completion of the ROV's. Any item found not to be in accordance with the Rules or approved plans, or any material, workmanship, arrangement and performance found to be unsatisfactory are to be rectified.

204. Tests and Trials

1. General

- (1) ROV's and their back-up systems undergo constructional and acceptance tests in the manufacturing works, Wherever applicable, all the tests and trials prescribed are to be performed and documented.
- (2) All welding parts should be inspected with NDT (non-destructive test) as appropriately.
- (3) All materials used for ROV's should be examined and conformed by the Society and the test reports shall be submitted.

2. Total system

On completion, the ROV together with its necessary back-up system, e.g. the control station, power supply and launch/recovery facilities, is to be subjected to a functional and acceptance test which

shall include at least the following elements :

- (1) assembly inspection (except where this has already been carried out during supervision of construction),
- (2) verification of weight and buoyancy,
- (3) testing of all safety devices,
- (4) functional test of diving and trimming system,
- (5) functional test of mechanical, electrical and optical equipment including the holding and working devices,
- (6) underwater trial run,
- (7) verification of all important measuring instruments,
- (8) high-voltage and insulation testing of electrical equipment.

3. Supporting structure

A check is to be carried out on the pressure equalization of those parts of the supporting structure which are not resistant to pressure. When necessary, welding parts are to be inspected by NDT(non-destructive test)

4. Pressure vessels

- (1) A hydraulic pressure test is to be performed before the vessels are insulated or painted. This shall not cause leakage or any permanent deformation of the walls.
- (2) The test pressure for vessels is generally equal to 1.5 times the maximum working pressure when the pressure is applied internally.
- (3) Vessels liable to be subjected to an external pressure corresponding to the maximum permissible operating depth of the ROV are to undergo an external-pressure test. The test pressure must be equivalent to at least 1.3 times the nominal diving depth.

5. Piping, valves, fittings, hoses and umbilicals

- (1) After installation, all pipes are to be subjected to a pressure and tightness test at 1.5 times the design pressure.
- (2) Proof is to be submitted to the Society of the bursting pressure of each type of hose line. For liquids, hose line must be able to withstand at least 4 times and, for gases, at least 5 times the maximum working pressure.
- (3) Each hose line is to be subjected to a hydraulic pressure test at least the maximum working pressure.
- (4) Where hose lines are subjected to an external excess pressure, proof is required that 1.5 times the difference between the internal and external pressure can be tolerated without failure.
- (5) Umbilicals are to undergo a tightness test in which all the hose lines are simultaneously subjected to their respective maximum working pressure and measurements are performed on the electrical lines to verify that the insulation values specified by the manufacturer are maintained at a test voltage equal to or greater than 500 V. The effectiveness of the strain-relief device is also to be tested.
- (6) Where the tether forms an internal part of the umbilical, the mechanical properties are to be tested.

6. Pumps

On completion, pumps are to be subjected by the manufacturer to a tightness test at maximum working pressure and to a performance test.

7. Controls for depth, trimming and positive/negative buoyancy systems

- (1) Trimming, bilge and ballast systems are to undergo a functional test.
- (2) The diving tank venting system and control elements(where present) are to be subjected to a functional test.

8. Propulsion and maneuvering equipment

Operation of the propulsion and maneuvering equipment is to be verified in the course of the underwater trial run.

9. Electrical equipment

- (1) Electrical machines and switchboards including operating and control station, and automation, alarm and safety equipment are to be inspected and tested in the manufacturer's work.

- (2) All electrical systems and equipment are to be inspected and tested prior to commissioning of the ROV.
- (3) The settings and thresholds of the electrical protective devices are to be checked, and in addition the ROV electrical systems are to be subjected to a high voltage and insulation test at a test voltage equal to or greater than 500 V.
- (4) After the connectors have been fitted, each manufactured length of power-supply cable is to be subjected to a pressure test at 1.3 times the maximum operating pressure.

10. Clamping and positioning devices

Clamping and positioning devices are to undergo a functional test comprising at least the following elements.

- (1) the specified clamping power of the clamping device.
- (2) the limits of power and movement of clamping devices and the alignment of the ROVs
- (3) simulated power failure
- (4) maintenance of course and depth with automatic positioning

11. Working appliances

As a minimum requirements, working appliances are to be tested with regard to :

- (1) capacity to fulfil their specified function
- (2) control and monitoring
- (3) operation of safety devices

12. Automation, navigation and locating equipment

- (1) Indicators and monitors are to be checked for ergonomic arrangement, accuracy of readings and limit settings.
- (2) Automatic monitoring systems are to be checked for faultless operation under service conditions.

13. Garage

- (1) Launching and recovery of the garage together with the ROV is to be verified a functional test.
- (2) Exit and entry of the ROV to and from the garage is to be tested under water (functional test of all the garage equipment)
- (3) The garage lifting attachment is to be tested at twice the working load.

14. ROVs control Stations

ROVs control stations are to comply with **Pt 9, Ch 7** of **Rules for the Classification of Steel Ships**.

15. Launching and recovery system

Launching and recovery system are to comply with **Pt 9, Ch 7, 607. 12.** of **Rules for the Classification of Steel Ships**.

205. Markings

1. All important valves, fittings, operating elements, indicators and alarms are to be provided with a permanent marking resistant to seawater.
2. All pressure vessels and pressurized gas containers are to be prominently and permanently marked with the following details :
 - (1) manufacturer or supplier
 - (2) maker's number
 - (3) type of manufacture
 - (4) maximum working pressure (bar)
 - (5) test pressure
 - (6) capacity (liter or M^3)
 - (7) empty weight (or pressurized gas container)
 - (8) type test mark on type tested pressure vessels

Section 3 Survey after Construction

301. Survey after construction

In the survey after construction, the actual scantling of main parts of the ROV's are to be measured in addition to such examinations of the construction, materials, workmanship, actual conditions of structure, outfitting, equipment and performance.

302. Submission of plans

In the survey after construction, plans and documents as may be required for classification survey during construction are to be submitted. If plans cannot be obtained, facilities are to be given for the Society's surveyor to take the necessary information from the ROV's.

303. Tests

In the Survey after Construction, the hydraulic pressure tests, water tight tests and performance tests are to be carried out in accordance with the requirements of the Rules. However, these tests may be dispensed with, provided that sufficient data on the previous tests are available.

Section 4 Periodical and other surveys

401. Kinds of surveys

1. Annual Survey

Annual Surveys are to be carried out within 3 months before or after the anniversary date from the completion date of the initial survey or of the previous Special Survey.

2. Special Survey

Special Surveys are to be carried out at a date of exceeding 5 years from the completion date of survey or the due date of the previous Special Survey. However, if Special Survey are carried out at a date which is to be more than 3 months earlier than the due date of Special Survey, the next Special Survey is to be assigned at the date of 5 years after the completion date of the concerned Special Survey.

3. Occasional Survey

All classed ROV's systems are to be subject to Occasional Surveys when they fall under either of the following conditions at periods other than those of Special Survey or annual Survey:

- (1) When main parts of systems, or important fittings or equipment which have been surveyed by the Society, have been damaged, or are about to be repaired or altered.
- (2) When safety valves are opened up or when settings of safety valves are altered.
- (3) Other cases where surveys are designed or whenever survey is deemed necessary by the Surveyor.
- (4) When the due dates of surveys are to be postponed.

402. Annual Survey

The followings are to be tested and checked in Annual Survey.

1. Examination of documents relating to the ROV's system and scrutiny of the operation records.
2. The pressure vessel including all fixtures, penetrations, doors and covers, seals, locking devices etc., is to be inspected for visible damages, cracks, deformation, corrosion and fouling.
3. The entire power supply system including the emergency supply of the ROV's system is to be subjected to external inspection.
4. Switching from the main to the emergency electricity supply is to be tested.
5. Insulation measurements are to be performed on the electrical equipment.

6. The accuracy of all important instrument readings is to be checked (e.g. depth gauge, gas analyzer, etc.)
7. All emergency systems are to undergo a function test.
8. The launch and recovery system is to be checked for visible damages, cracks and deformation and is to undergo a functional test including an emergency brake test (power failure)
9. All high-pressure gas supply, charging hoses and umbilical are to be checked for visible damage and tightness.
10. Performance of a tightness test on the pressure vessel at maximum permissible operating pressure using air.
11. Verification of the setting pressures and resetting pressure of safety valve and safety device and alarm system
12. Function test on control station, overall system and electric system.
13. Function test on all alarm systems
14. Operation test on Launch and recovery system.
15. Measurements on Launch and recovery at the corrosion and abrasion part.
16. For 10 years over, hydraulic test is to be carried out on all pressure vessels and if necessary an endoscope inspection may be added.

403. Special Survey

In Special Survey the followings are to be tested and checked in addition to the items specified in Annual Survey.

1. A tightness test is to be performed on the pressure vessel at 1.1. times the maximum permissible operating pressure using air
2. Non destructive test on the welding parts and thickness measurement on the pressure vessel, etc.
3. Emergency ballast release and buoyancy test.
4. Pressure vessel and its apparatus not capable of satisfactory internal inspection and those whose satisfactory condition cannot be definitely established by internal inspection are to be inspected by non-destructive test or hydraulic pressure test.
5. Where necessary overhaul inspection on the hydraulic cylinder, etc. of hydraulic system.

404. Postponement of Special Survey

If ROV's system at the time of the Special Survey is not in a port in which it is to be surveyed or if ROV's system is in transit to another port to be surveyed, the due date of Special Survey may be postponed within the period of 3 months at the request of the owner through the approval of the Society.

Section 5 Documents and Drawings for Approval

501. General

Before commencement of fabrication, plans and other documentation giving the required particulars are to be submitted in triplicate.

502. Drawings and documents

The following drawings and documents are to be submitted :

- (1) General arrangement
- (2) Cross sectional assembly
- (3) Details of welding joints
- (4) Details of Propulsion and maneuvering equipment

- (5) Construction of Pressure vessel and High pressure pipes
- (6) Electric, hydraulic and mechanical equipment system
- (7) Thrust arrangement
- (8) Robot-arm expansion
- (9) Details of umbilical and tether
- (10) Details of piping, valves, equipments
- (11) Buoyancy and stability arrangements
- (12) Other drawings when necessary
- (13) Diagram with sequence of control and operating function.
- (14) Procedure of supply of electric, hydraulic and pneumatic.
- (15) Enclosed grade of all electric equipments
- (16) Supporting structures, contact, materials.
- (17) Electrical power supply system
- (18) Details of motor and battery
- (19) Specification of valves, hoses and pipes
- (20) Load calculation (load, shearforce, and moment for construction)
- (21) Calculation and data for trim and ballasting
- (22) Operation manual and maintenance

Section 6 Design and Construction

601. General

1. ROV's and their components are to be designed for the conditions in which the specification states that they are to be used.
2. ROV's are to be designed and constructed in such a way as to ensure safe operation and allow proper maintenance to be carried out.
3. ROV's are to be so equipped that the dive operator is able to determine its position and operating condition.
4. ROV's which operate with diver support are to be equipped with a TV unit for monitoring the work site and with an EMERGENCY STOP device which can be operated from the ROV dive control station.
5. Due care is to be taken to ensure that inadvertent movements cannot cause the ROV to destroy itself or equipment located at the work site or to become separated from its control and supply lines.
6. ROV's are to be designed that they respond in a defined manner (e.g. by positive buoyancy) to a failure of the control and power supply system.
7. Measures are to be taken which as far as possible prevent the ROV from becoming trapped. Propellers are to be provided with suitable protective devices.

602. Ambient Conditions

1. The design, selection and arrangement of all machines, devices and equipment located on board ROV's shall, as a minimum requirement, be governed by the following ambient conditions. Other ambient conditions may be approved for ROV's which are used only in restricted areas.
2. For inclined position, faultless operation is to be guaranteed at inclinations of up to 22.5 degree (static and dynamic) relative to the mounted position in any direction. Transitory inclinations of up to 45 degree shall not give rise to any undesirable functional changes or damage, particularly to the bearings of machines.
3. For water, the design of ROV's and components is generally to be based on seawater in the temperature range -2°C to $+32^{\circ}\text{C}$ with a salinity of 35 ppm and density of 1028 kg/m^3 . A ratio of 0.101 bar/m is to be used for converting diving depth to pressure.
4. For sea state, the launching and recovery system for ROV's is to be designed for a sea state with a significant wave height of at least 2 m. Allowance is to be made for accelerations of 2 g in the

vertical direction and 1 g each ($g = 9.81 \text{ m/s}^2$) in the transverse and longitudinal direction.

5. For climatic conditions, the transport, maintenance, inspection and dry testing of ROVs on board the supply ship and the launching and recovery system for the ROV are to be based on salty air in the temperature range from -10°C to $+55^\circ\text{C}$ with a relative humidity of 100%.
6. For the protected dive control rooms for ROVs installed on board supply ships allowance is to be made for a relative humidity of 80 % at a reference temperature of 45°C .
7. For explosion protection, ROVs intended for use in or from areas subject to an explosion hazard (e.g. oil or gas production platforms) are to be provided with suitable explosion protection.
8. For other ambient conditions, where appropriate, the design of the ROV should also take account of the ambient conditions occurring during possible transport by air (low pressure).

603. Materials

1. Materials for ROVs and their equipment shall be so selected that the ROV can be safely operated throughout its planned life under the proposed ambient and service conditions.
2. Materials must be suitable for the proposed application and have been approved by the Society.
3. The manufacture, processing and testing of materials must proceed in accordance with approved standards or to approved manufacturer's specification which have been examined by the Society.
4. Materials for fixed buoyancy elements must be suitable for the proposed pressure and temperature ranges and have a low water-absorption factor.
5. Tethers are to be manufactured and tested in accordance with an approved standard or to approved manufacturer's specification which have been examined by the Society.
6. To the extent that this is necessary to the operation of the ROV and adequate protection by other means is not possible, materials must be resistant to the effect of the ambient media. In addition, materials must be mutually compatible.
7. Suitable proof, e.g. a manufacturer's certificate is to be provided testifying to the characteristics of materials used for parts subject to approval.

604. Pressure Vessels

1. Pressure vessels and pressurized gas containers are subject to the requirements stated in the Rules of this Society or other equivalent.
2. Acrylic plastic viewports (or windows) are to be designed and manufactured in accordance with **Pt 1, Ch 5, Sec 3**.

605. Supporting Structure, Garage Design

1. The frame and supporting structure of ROVs, including the garages (where these exist), are to be designed and constructed in accordance with approved codes of practice.
2. Approved methods of calculation are to be applied to the design of the supporting structure components and the garage construction. The structures are to be dimensioned in such a way that at the anticipated loads the effective stress does not exceed 60 % of the yield strength.
3. The lifting attachment of the ROV is to be so designed and arranged that the ROV can be launched and recovered under the maximum permissible sea state conditions.

606. Piping, Valves, Fittings, Hoses and Umbilicals.

1. Pipes are to be designed and installed according to approved standards.
2. Pipes which are liable to be subjected in service to pressures higher than the designed pressure must be provided with a pressure-relief valve, safeguarding against dangerous blow offs.
3. Shutoff valves must conform to an approved standard. Valves with screw-down valve caps or spindles are to be safeguard against the unintended loosening of the cap.

4. Hand-operated shutoff valves are to be closed by clockwise rotation. The closed and open position of functionally important shutoff valves must be clearly indicated. If they have to be handled by divers in water they have to be constructed such that they can be easily operated by divers wearing diving gloves.
5. Hose fittings are to be made of corrosion resistant material and are to be designed to prevent unintentional release.
6. Hose lines, including their components, must be demonstrably suitable for the proposed operating fluids, pressures and temperatures. Only types approved by the Society should be used.
7. Hose lines for liquids/gases are to be so designed that the bursting pressure is equivalent to at least 4 and 5 times respectively the maximum working pressure.
8. Hoses are to be fastened to their connectors by non-detachable hose couplings.
9. Where hoses are fitted with wire-mesh inlays which are not resistant to corrosion, the mesh is to be protected from water.
10. Umbilical hose lines must be provided with strain-relief devices unless they are provided with tethers.
11. Umbilicals must be protected against abrasion and damage. Where protective sheathing is used, care is to be taken to ensure that internal pressure does not build up in the event of minor hose leakages. Metal inlays in the protective sheathing are to be avoided.
12. Electrical cables in the umbilical must meet the requirement of the Rules.

607. Devices for Controlling/Adjusting Depth, Trim and Positive/Negative Buoyancy.

1. ROV's are to be equipped with devices for controlling/adjusting the depth and positive/negative buoyancy. It is necessary to ensure that these devices are effective under all the specified condition of heeling and trim.
2. Depending on the type of ROV, the following may be regarded as devices for controlling the depth, trim and positive/negative buoyancy.
 - (1) fixed or changeable ballast and trimming weights in combination with the tether or launch and recovery system.
 - (2) fixed buoyancy elements, e.g. of pressure resistant foam.
 - (3) floodable ballast and trimming tanks
 - (4) propeller drives
3. The control devices must be capable of compensating for the expected differences in water density and of ensuring that the ROV attains a defined diving state.
4. Remote-operated device for controlling depth, trim and positive/negative buoyancy must be capable of being operated from ROV dive control console. In addition, the console shall in these cases provide a continuous indication of the depth of the ROV.

608. Propulsion and Maneuvering Equipment

1. With regard to their type, number, size and arrangement, propulsion devices shall be designed to meet the requirements arising from the proposed application of the ROV.
2. Externally located propulsion unit shall be pressure-balanced or designed for the ROV's maximum diving pressure.
3. Propulsion plants of ROV's are to be designed for intermittent and continuous operation.
4. Electric propulsion motors are to be designed in accordance with the requirements of the Rules
5. Shaft penetrations through the walls of pressure vessels are to be provided with a proven shaft seal designed for the maximum diving depth.
6. Propellers are to be so arranged that the danger of unintentionally trapping the ROV or fouling the umbilical or tether is largely eliminated.
7. Devices for controlling the speed and/or the direction of rotation are to be so designed that the

propulsion motor can be stopped in the event of their failure.

8. The operating condition of the propulsion units (thrust and direction of thrust and/or speed and direction of rotation) must be displayed at the ROV dive control station.
9. ROVs are to be fitted with suitable equipment giving the ROV the necessary maneuverability.

609. Clamping and positioning Devices

1. Clamping devices are to be so designed and constructed that they can be set to a specified holding power. In addition, means are to be provided to enable the holding claw or similar mechanism to be released in case of a power failure.
2. Positioning devices are to be fitted with suitable siting/locating sensors. The controllability of the positioning devices must be geared to the function of the ROV.

610. Working Appliances

1. Working appliances are to be mounted on the ROV in such a way that the danger of unintentionally trapping the ROV or fouling the umbilical or tether is largely eliminated.
2. Tools which can be changed by remote control are to be provided with means for preventing the entry of seawater into the supply system.
3. Tools capable of rotating through 360° are to be so designed that any power, supply or control connection cannot be twisted off.

611. Electrical Equipment

1. All electrical equipment is to be so designed and installed that it is operational and serviceable under the design conditions specified for the ROV.
2. Systems for which even a brief failure cannot be tolerated are to have battery support or an uninterruptible power supply.
3. Where batteries are used, **Pt 6 of Rules for the Classification of Steel Ship** are to be observed for the battery systems. Battery chargers must have a characteristic conforming to the battery manufacturer's recommendations.
4. The supply to the control station for the ROV shall be ensured by two mutually independent circuits with changeover facility. Alternatively a direct supply may be routed from the emergency switchboard of the supply ship or the power supply station. Where ROVs operate with dive support, electrical systems whose failure could endanger the divers are to be designed for high-availability, e.g. with battery back-up.
5. Devices are to be provided enabling the ROV to be de-energized during launching and recovery.
6. approved supply systems are :
 - (1) direct current and single-phase alternating current, with both conductors insulated from the hull of the submersible.
 - (2) three-phase alternating current with the three conductors insulated from the hull of the submersible.
Networks with an earthed neutral are not permitted.
7. The permissible voltage and frequency deviation stated in **Pt 6 of Rules for the Classification of Steel Ship** shall not be exceeded.
8. A power-balance shall be prepared to prove that the rating of the main power supply is sufficient.
9. Appropriate diversity factors may be assumed for consumers which are intermittently connected.
10. A power margin is to be provided for transient peak loads (e.g. on motor start-up)
11. The emergency power supply is to be so designed that, if the main power supply fails, the ROV can be placed in a stationary operating condition which at no times prevents a danger. From this stationary condition it must be possible either to recover the ROV safely or to continue its task after the main power supply has been restored.

12. Electrical distribution systems are to be so designed that a fault or failure in one circuit does not impair the operation of other circuits.
13. In normal operation the emergency power distribution system may be fed via an interconnector feeder from the main power-distribution systems.
14. The lengths of cable from storage batteries to the switchboard are to be kept as short as possible. These cables are to be laid separately to the specially protected against mechanical damage.
15. In switchgear, measures are to be taken for the prevention of parasitic voltage. Safety-voltage circuits shall not be run in the same conductor bundle as higher-voltage circuits or in the same cable duct. Terminals for different voltage levels are to be arranged separately and marked accordingly.
16. Each circuit is to be protected against short-circuit and overload.
17. All consumer circuits are to be designed for all-pole switching
18. Where ROVs operate with diver support, a continuous insulation-monitoring system is to be provided which actuates a visual and audible alarm at the ROV control station when the value drops below a minimum level. Where the possibility of danger to humans cannot be ruled out, provision is to be made for the automatic disconnection of the circuit concerned.
19. ROVs with electrical equipment are to be provided with an earthing and equipotential system. All non-current-carrying metal parts are to be connected to this. Where earthing is not via the fastenings, protective conductors are to be fitted. Where protective conductors are used, the following points are to be observed :
 - (1) The protective conductor must take the form of an additional cable, and additional line or an additional core in the power cable. Cable sheaths or armouring shall not be used as protective conductors but are to be connected to the protective conductors.
 - (2) A conductor which carries current in normal operation shall not simultaneously be used as a protective conductor and shall not be connected jointly with the latter to the hull of the ROV.
 - (3) The cross-section of the protective conductor must be equivalent to at least half the cross-section of the main conductor. However, with cross-section of up to 16 mm^2 the cross-section must be the same as that of the main conductor. With separately laid protective conductors the minimum cross-section is 4 mm^2 .
In the propulsion system, the rating of the protective conductors is to be based on the maximum possible short-circuit currents of the equipment concerned of the available protective devices and a maximum temperature rise of the protective conductor of 90°C .
 - (4) Machine and equipment mounted on insulated vibration dampers are to be earthed via mobile cables, lines or copper braids.
 - (5) Protective conductors must be connected to the hull of the ROV at points which can easily be checked.
 - (6) In an easily accessible position on the superstructure and on the hull of the ROV a connecting plate with M12 stud bolts is to be provided to which, e.g. on the supply ship, a protective conductor can be connected without the use of tools.
20. IP44 type protection is stipulated as a minimum requirement for the electrical equipment in ROVs. IP23 is sufficient for the devices incorporated in the ROV control station
21. The housings of non - pressure - compensated electrical equipment for underwater use are to be designed for the test diving-depth as a minimum requirement.
22. Umbilicals, underwater cables and lines must be impervious to transverse water penetration (i.e. no water shall penetrate the sheath) and are to be designed for the test diving depth as a minimum requirement.
23. Drum cables are to be so designed that mechanical forces are not transmitted by electrical components.
24. Penetration and plug-and-socket connections are to be designed and tested in accordance with **Pt 6 of Rules for the Classification of Steel Ships**.
25. Insulation classes A and E are not permissible for the windings of electrical machines.

612. Automation, Navigation and Locating Equipment

1. All devices for automatically monitoring and controlling the operating parameters of a ROV are to be so designed and constructed that they function properly under the design and ambient conditions laid down for the Vehicle.
2. Computer-aided operational control systems for navigating and/or monitoring and controlling the ROV are permissible.

Details of the scope and redundancy of the equipment and the extent and nature of the tests are to be agreed with the Society.
3. All monitoring and control devices are to be clearly inscribed and identified.
4. Indicating instruments and synoptic displays are to be designed and inscribed in such a way as to facilitate clear and rapid readings.
5. No fault or failure whatsoever in the automation system shall lead to an uncontrollable operating condition.
6. Automation equipment shall as far as possible be protected against incorrect operation.
7. Automation equipment must be capable of maintaining the operating parameters specified for the ROV.
8. All inadmissible deviations from the operating parameters must automatically actuate a (visual and audible) alarm at the ROV dive control station. The same applies to automatic changeovers in the supply system and to faults in the control and monitoring system.
9. In addition to electronic control and monitoring devices, independent safety devices must be provided which prevent a fault in a system from creating an unsafe or undesirable operating condition.
10. Automatically operating monitoring and control devices must be capable of being switched to manual operation at any time. Exception to this rule are to be agreed with the Society.
11. The thresholds of automation devices are to be co-ordinated in such a way that, when a limit value is reached, an indicating signal is actuated followed by the response of the safety devices on the expiry of a specific warning period or on the further variation of the process variable at a preset speed.
12. The overall behaviour of the automation equipment must be compatible with the time constants of the devices and components in the system.
13. The criterion for the noise immunity of electronic systems is in accordance with the Rule of **Guidance for Approval of Manufacturing Process and Type Approval, Etc.**
14. Electronic automation equipment shall comprise easily interchangeable modules using the plug-in system wherever possible.

The modules should be largely standardized, and the number of module types should be kept small to reduce the spares inventory.
15. Plug-in cards must be clearly marked or coded as a safeguard against accidental confusion.
16. Measures must be taken to prevent condensation inside electronic equipment even when it is switched off.
17. Wherever possible, automation equipment should be operable without forced ventilation. The operation of any cooling system is to be monitored.
18. Components must be effectively fastened. The mechanical loading of wires and soldered connection by vibration and shuddering is to be minimized.
19. The construction of systems and equipment should be simple and straightforward. Easy accessibility for measurements and repairs is desirable.
20. Signalling and open and closed-loop control devices for safety-related functions must be constructed on the fail-safe principle. I.e. defects such as short-circuit, earth faults and breaks cannot produce conditions endangering humans or equipment. This is to be based on the assumption of signal faults.

The failure of one module, e.g. due to short-circuit, shall not result in damage to other modules.

21. In programmable controllers the electrical values of the sensors shall meet the safety requirements for control devices. This means primarily:
 - (1) H-level start up, i.e. by energization via NO contacts.
 - (2) L-level shutdown, i.e. by de-energization via NC contacts.
22. Control devices for safety function, e.g. emergency-stop sensors, are to be independent of a programmable controller and are to act directly on the output device, e.g. stop solenoid valve. They are to be safeguarded against unintentional operation.
23. Programmable controllers should be non-interfering and in case of fault should not cause disturbances in program-independent safety interlocks and safety switching sequences for fixed subroutines.
24. Freely accessible potentiometers and other components provided for adjustment or working point setting must be capable of being locked in the operating position.
25. Switchgear interfaces must be so designed that contact chatter has no adverse effects on the operation of the equipment.
26. Printed conductors forming part of circuits extending outside the enclosure containing the printed circuit boards must be conditionally short-circuit-proof, i.e. in the event of an external short circuit only the protective devices provided may respond without destroying the printed conductors.
27. The equipment shall not be damaged by brief voltage surges in the ship's power supply which may be caused by switching operations. The design shall allow for overvoltages amounting to approximately twice the rated voltage and lasting 1 ms.

Where equipment is supplied from static converters, allowance is to be made for periodic voltage pulses lasting about 0.5 ms. The amplitude depends on the type of converter and must be investigated in each case.
28. Power supply units for automation equipment must at least have short-circuit and overload protection.
29. The reference-conductor system is to be so designed that breaks are as far as possible eliminated. This is achieved, for voltage and frequency deviations mentioned in accordance with the Rules.
30. Automation equipment must be capable of reliable operation with the voltage and frequency deviations mentioned in the Rules **Pt 2, Sec 10 of Guidance for Approval of Manufacturing Process and Type Approval, Etc.**
31. For monitoring and controlling the ROV a control station or console is to be provided at which all the important data relating to the vehicle are displayed and all the controls and monitors, including TV and communications facilities, are located which are needed for the operation of the ROV.
32. The control station instruments for supervision, controlling and operating the ROV are to be grouped and arranged on ergonomic principles.
33. As far as feasible and rational, initiated control functions are to be indicated by synoptic displays on the console or switchboard, as applicable.
34. All sensors for registering the ambient and operating conditions of ROVs shall have been type-tested by the Society.
35. All the electronically operated navigation and locating equipment necessary to the safety of the ROVs is to be connected to the vehicle's emergency power supply. Its operational or stand-by status must be clearly indicated at the control station.
36. As far as is feasible and rational, ROVs should be equipped with an automatic emergency locating device (pinger).
37. The fitting of the ROVs with navigation and locating equipment shall comply with any official regulations applicable in the home country.

613. ROVs control station

1. ROVs control station should be located at a place where the operator generally is able to know the operation condition of all the system of ROV's and apparatus but not installed within dangerous area.
2. Piping system is to be designed as far as possible from the maneuvering apparatus.
3. The ROVs control station is to be separated from other spaces by bulkheads and decks of type A-0 class.
4. The fire extinguishing system is to be designed and constructed in such a way that it should not cause the equipment and the maneuvering to be disorder against fire wherever possible.
5. Alarm devises should be appropriately audible and viable in/outside dive control station.
6. Indicators / alarm devices signed from depth, remained battery capacity, operating condition of launch and recovery system and other functions with hazardous elements should be connected to an independent supply sources. Emergency stop devices are also to be independent of others.
7. Direct communication system should be equipped such a way that it is to be capable of connecting among the following positions
 - (1) dive control station
 - (2) other control room on a support ship
 - (3) maneuvering station of launch and recovery system
 - (4) remote-control position of ROV's.

614. Launch and Recovery system

1. The requirements of Lunch and Recovery system are to be complied with **Pt 9, Ch 7, Sec 14 of Rules for the Classification of Steel Ships.**
2. In addition the followings are to be complied with :
 - (1) Unless other wise specified in the followings, the mechanical equipment of launch and recovery system for lifting gear is to be confirmed to **Pt 9 of Rules for the Classification of Steel Ships.**
 - (2) The launch and recovery system must be capable of effecting the safe launch and recovery of the ROV under the ambient conditions-mentioned. Where necessary, it is to be fitted with de-vices for reducing the dynamic loads.
 - (3) All interchangeable parts such as blocks, hook, shackle etc, must conform to approved standards and be designed for twice the working load.
 - (4) The maximum static tensile stress on steel cables due to the working load shall not exceed 1/8 of the proved rupture strength. Where cables of natural or synthetic fibers are used, the maximum static stress due to the working load shall not exceed 1/10 of the proved rupture strength.
 - (5) The launch and recovery system is to be designed for a defined working load based on the weight of the ROV including its equipment and ballast weight. Without more accurate evidence, seaway effects may be allowed for by increasing the relevant working load by 50 % for the purpose of calculation and dimensioning and assuming that it can act at an angle of 12° off vertical in any direction.
 - (6) Launch and recovery systems are to be equipped to prevent excessive twisting of the ROV during recovery. ↓

PART 3
TOURIST SUBMERSIBLES

CHAPTER 1 TOURIST SUBMERSIBLES

Section 1 General

101. Application and Descriptions

1. The Submersibles engaged in coastal area and carrying passengers (hereafter referred to as "Tourist Submersibles"), in spite of the Rules for the Classification of "Underwater Vehicles" , where these requirements of the Guidances are complied with, may be considered that as satisfied with the requirements of the Rules.
2. Despite of the above 1 the requirements specified in **Pt 1, Ch 5** (Pressure Hull) and **Ch 9** (Piping system, Pumps and Compressors) of the Rules shall be complied with.
3. Definitions used shall be according to **Pt 1, Ch 1, 102**. Tests and Marking for all apparatus fitted in the tourist submersibles shall comply with the relevant requirements of **Pt 1, Ch 1, Sec 3** and **Sec 4**.

102. Documents and drawings for approval

1. For the tourist submersibles requiring classification survey during construction, three copies of the following documents and drawings are to be submitted to be approved by this Society.
 - (1) Midship Section
 - (2) Pressure Hull Construction
 - (3) Buoy tank construction
 - (4) Construction and arrangement for external pressure windows, covers, penetrated attachments to pressure hull and shaft bearings, pipings, valves, discharging pumps, cables, etc.,
 - (5) Construction and arrangements for evacuation system
 - (6) Arrangement and system for launch and recovery equipments
 - (7) Construction and arrangement for maneuvering devices
 - (8) Construction and arrangement for outfittings such as balancing chains, emergency drop weights, Transmission Cables, Distress signal Buoy, etc.,
 - (9) Construction and arrangement for pressure vessels and high pressure air pipes
 - (10) Piping system including ballasting and trimming
 - (11) Arrangements for Engine room and Battery room
 - (12) Shafting arrangement
 - (13) Wiring diagram for power system
 - (14) Investigation Table for electric load analysis
 - (15) Manufacturing guides for Pressure hull (Workmanship method, allowable limitation, Inspection standards, etc)
 - (16) Diagram for life support system and performance test method
 - (17) Fire protection construction and Fire fighting arrangements
 - (18) Lighting arrangements
 - (19) Other drawings if needed by the Society
2. Three copies of the following drawing and documents shall be submitted for reference.
 - (1) Specification
 - (2) Lines
 - (3) General arrangements
 - (4) Hydrostatic curves
 - (5) Weight balancing trim calculation
 - (6) Stability calculation
 - (7) Stable voyage calculation during diving (Maximum persons on board)
 - (8) Strength calculation for pressure hull
 - (9) Strength, Stability and Buoy speed calculation for pressure life saving apparatus to evacuate persons on board
 - (10) Calculation of high pressure air volume for buoy
 - (11) Calculation of capacity for life support system
 - (12) Plan for Sea trial
 - (13) Other drawings and documents if needed by the Society

103. Voyage condition

1. The tourist submersibles, in any case, shall not go under water more than maximum submerging depth and time.
2. The tourist submersibles shall make a voyage on the performance allowable limit according to the operational instructions specified in **104.** and while driving, it shall go on subject to having little of pre-buoy and trim.

104. Operational Instructions

At first, the owner of tourist submersible requiring classification survey, for the purpose of safety, shall make out the operational instructions specified in the following items and send off it to the Master on board. And then the copy shall be submitted to the Society.

1. Maximum diving depth and time
2. Maximum speed during diving
3. Trim limitation during diving
4. Emergency stop during diving
5. Pressure hull's compression variety derived from sea water's specific gravity and driving depth, and Buoy's variety derived from difference of water temperature, etc.
6. Caution about operation and maintenance of apparatus for diving and buoyancy
7. Caution about operation and maintenance of apparatus for emergency buoyancy
8. For equipments intended for evacuating during diving, caution about operation and maintenance of the equipments
9. Charging guide of battery and an allowable limitation
10. Caution about operation and maintenance of life support system
11. For breathing air in pressure hull, standard quantities of oxygen and carbon dioxides and those allowable limitation
12. Others if needed by the Society

105. Obligation to report

In an abnormal condition occurred during diving or buoying, the owner or master is required to report the matters to this Society immediately.

106. Equivalent

Where tourist submersibles are designed not to be complied with these Rules or manufactured by new technology but not reviewed fully about the special performance, the special data and tests may be required to send off to the Society.

Section 2 Classification Registry

For classification registry, **Pt 1, Ch 2** of the Rules are to be applied and the following requirements shall be added.

201. Classification Survey during Construction

For tourist submersible requiring Classification Survey during construction, the requirements of **Pt 1, Ch 2, Sec 2** of the Rules shall be applied.

For initial classification survey, the performance test of life support system shall be complied with as follows

1. life support system shall be tested at shore for hours of 1.5 times normal diving time after taking maximum persons on board. When testing under the attending surveyor, the report such as oxygen, carbon dioxides, hydrogen and internal pressure shall be carried out per every 15 minutes.
2. Sea trial shall be carried out subject to the condition of **1** above. However, the normal diving hours are to be applied.

202. Classification Survey after Construction

For tourist submersible requiring Classification Survey after construction, the requirements of **Pt 1, Ch 2, Sec 3** of the Rules shall be applied.

Section 3 Periodical and Other Survey

301. Kinds of Surveys

Kinds of Survey shall apply to the requirements of **Pt 1, Ch 3, Sec 1** of the Rules.

302. Performance of Survey

For Surveys of tourist submersibles registered on the Society, the following items shall be complied with.

1. Intermediate Survey

- (1) Visual inspection of pressure hull
- (2) Operation test of open/close indicating devices
- (3) Insulation test of electrical equipments
- (4) Operating test of controlled water depth devices.
- (5) Performance test of Battery
- (6) Function test of air conditioning.
- (7) Verification of calibration for water depth meters, Hydrogen gas detector and those removing devices, pressure gauge of pressure vessel. navigation aids, etc.
- (8) Where fitted things such as emergency drop weights, balancing chains, transmission cables or distress signal buoy, etc. For the emergency drop weights, the separation and drop test is to be carried out while the submersibles may be placed in a drydock or upon a slipway.

2. Special survey

In addition to the intermediate survey, the following requirements shall be complied with.

- (1) Internal inspection for each tanks (including buoy tank)
- (2) If necessary, Visual inspection for external pressurized windows, covers, pipes and valves, and drainage pumps and moving steel attachments separated which pass through pressure hull.
- (3) If needed by the Society, the thickness of pressure hull's plate and frame tripping shall be measured.
- (4) Overhaul inspection for propulsion machinery and auxiliary machine, etc. and the visual inspection for pressure vessels and those relevant piping system
- (5) Function test for shipborne barometer low alarm devices and equivalent ones used for same purpose.
- (6) For evacuation apparatus other than escape method to fill waters with one compartment of pressure hull, the function test of the evacuation is to be carried out.
- (7) Running speed test under water
- (8) Performance test at maximum diving depth.
- (7) Running speed test under water at Maximum diving depth
- (8) Performance test at 1.5 times of maximum diving depth : after reaching 1.5 times of max. diving depth, or equivalently pressurized, following items is to be confirmed.
 - (a) Pressure hull should not have any deformation and/or leakage.
 - (b) Viewport, access hatch and hatch cover should not have any deformation and/or leakage.
 - (c) Watertight parts which is penetrated by Pipes, cables and etc should not have any leakage.
 - (d) Drainage pump operation test is to be carried out
- (9) Function test of Life Support Systems
 - (a) All life support piping systems, including gas storage containers, are to be pressurized to the design pressure, using the fluid normally used in service, and tested for leakage.
 - (b) Gas storage containers are to be hydrostatically pressure tested to 1.25 design pressure and visually inspected internally (with a borescope) and externally, at least once during each Special Survey period and documents of such tests are to be maintained and reviewed.
 - (c) Alternatively, gas storage cylinders are to be hydrostatically pressure tested and visually inspected internally (with a borescope) and externally, at least once every 5 years by a qualified third party in accordance with the requirements of the code/standard of manufacture (such as the US Department of Transport (DOT) requirements).
 - (d) Where gas storage containers are fastened to the vessel's structure, bolts are to be removed for examination including the condition of the pressure vessels in way of the bolts.

303. Submission of records

The owners, when the periodical survey and other survey is completed, shall be required to submit to the Society the survey records such as ship's conditions, measured results, wear down dimension, etc.

304. Hull Construction

1. Freeboard, etc. in buoyancy

- (1) For tourist submersibles requiring towing, when buoying, the freeboard shall be kept appropriately.
- (2) For tourist submersibles designed to allow person to exit during buoy, when buoying, the exit height of pressure hull is to be sufficiently higher than water level

2. Provision against corrosions

Where the main parts of tourist submersibles are apt to get the corrosion, a proper protection against corrosion shall be taken or the thickness is to be increased as considering the materials used and environment condition, etc.,.

3. Provision against external damages

- (1) The pressure hull shall be kept from getting damages when berthing, etc.
- (2) For the hull structures other than pressure hull, during diving voyage, if it is apt to get mechanical damage or there is a part to give a significant effect to the tourist submersible's safety owing to these damages, it shall be protected or reinforced.

4. Provision of submersibles sailing on the water

For tourist submersibles sailing on the water after buoying, even though the window covers are closed, they shall be designed so that the water is visible or equivalent proper apparatus are to be provided. However, it may be not applied that the tourist submersibles are able to sail under the condition of opening of window covers.

5. Materials of Construction

- (1) The approved materials used for pressure hull shall be complied with **Pt 1, Ch 5, Table 2.5.2** of the Rules.
- (2) The materials consisted of other significant part of hull shall be complied with **Pt 1, Ch 1** of the Rules, and they shall be approved by the Society and have a sufficient strength based on the purpose used.

6. Fire protection materials

- (1) The materials consisted of pressure hull, as far as practicable, shall be of non-combustible.
- (2) As far as practicable, no ignition-source is to be at any position. Electrical heating devices and insulators are to include protection devices against over-heating.
- (3) Their components and materials used shall be of those to minimize the static electricity. If the flammable materials are provided in enclosed spaces, the fire-fighting system shall be designed to operate effectively outside the spaces.

7. Construction of pressure hull

- (1) The pressure hull shall have sufficient strength to the external pressure having 2.0 times max. pressure at maximum diving depth.
- (2) The external pressurized windows, covers, pipes and valves, etc. attached to pressure hull shall be constructed so sufficiently considerable that the strength is equivalent to a compressed strength of non-opening of pressure hull
- (3) For watertight parts of pressure hull which is penetrated by pipes, cables, shafts, etc., they shall be sufficient to meet watertight at 1.5 times of max. diving depth.

8. Stress relieving of pressure hull

In considering construction of pressure hull, using materials, welding connection type and welding method, if needed by the Society, the stress relieving for pressure hull shall be taken.

9. Construction member other than pressure hull

For construction member other than pressure hull and consisting of hull construction, the tourist submersible shall be sufficient to meet strength under normal working condition.

305. Construction and system for diving and buoy

1. Construction and system for diving and buoy

- (1) For diving and buoyancy, the buoy control system (buoy tank, trim control system) shall be provided. In this case, the size and construction of buoy tank, when buoying, shall be made to keep the required freeboard and the stability. And even if diving under declining condition, it shall be able to accumulate the air.
- (2) For the buoy tank, the venting valves shall be fitted so that the air is to be shut down or exhausted and buoyancy-air pipes shall be provided. In this case the air piping system is to be sufficiently arranged to prevent the buoyancy-air pipes from damaging outside.
- (3) For pressure vessel having high pressure air for buoyancy, its capacity shall be sufficient based on the size of pressure hull, maximum diving depth, etc. And the vessel is to be firmly attached to the hull and be sufficient to prevent the vessels from damaging outside. Inside the pressure hull the indicating devices for air condition of the vessel shall be provided at the position to see easily.
- (4) In maximum diving depth the apparatus to control hull's weight and trim shall be provided. This apparatus shall be sufficient to control the buoying speed.
- (5) When discharging pump is used as the apparatus specified in above (4), the pump shall be designed to pump out fully at the discharging pressure higher than that related to 1.2 times maximum diving depth. At the outlet of discharging pump the check valve shall be fitted.
- (6) Each tank installed inside pressure hull shall be made to get a proper volume based on the request of navigation and to fit the indicator pointing out air-exhausting and the quantities. However, inside these tanks penetrated pipes passing through pressure hull shall not be fitted.

2. Construction and system for life-saving, etc.

- (1) For buoying in emergency, the emergency drop weight having a sufficient heft shall be provided. In this case emergency drop weight shall be provided with the releasing devices inside the pressure hull at maximum diving depth. The weight, after releasing, shall be arranged so that the tourist submersible is not inclined or overthrown. And if electric power is only used for operating of emergency buoy device, the emergency source is to be fitted so that the feeder is solely able to supply to this device.
- (2) Where pressure vessel having high pressure air for emergency buoy is ready or equivalent other apparatus ready, the emergency drop weight may be omitted.
- (3) In emergency person shall be able to escape from pressure hull. However, when it is permitted not to disturb them in considering the using purpose, the diving water area, the maximum diving depth and the efficiency of related devices, etc., it may be dispensed with and then the matter shall be send off to the Society.
- (4) If the pressurized life-saving to evacuate a group together, as a device specified in above items, is provided, it shall be capable of embarking the maximum persons on board. When buoying, the stability shall ensure that it do not prevent persons from getting off the device.

3. Stability assurance

- (1) Whenever buoying and diving or intended to dive, it is always possible to navigate safely.
- (2) Where 6 persons or more get on board, the hatches of entrances, in both the bow and the stern respectively, shall be fitted at least two(2) per compartment.
- (3) The hatches of entrances shall be able to be opened/closed inside or outside and the open/close condition is to be indicated at the control room.
- (4) If the hatches are provided with equalizing equipment against increasing internal pressure, as far as possible, its indicator shall be fitted and a proper notice shall be provided so that the crew only operate it.
- (5) In all conditions used, including releasing the emergency drop weight, the weight center shall be lower than the buoyancy center.
- (6) If needed by the Society, in the way of stability assurance, the electrical apparatus of tourist submersibles shall be complied with the requirements of **Pt 1, Ch 12** of the Rules.

306. Machinery installations

1. Machinery for Propulsion etc.

- (1) Machinery for Propulsion etc. shall be complied with the following requirements as well as **Pt 5** of **Rules for the Classification of Steel Ships**.
 - (A) The output of machinery for propulsion shall be kept to speed for navigation.
 - (B) The machinery for propulsion used, while diving, shall be made not to emit exhaust gases.
 - (C) Under a inclined condition of heeling and trim 15°, and pitching and rolling 60°, each machinery shall be kept not to hinder its function.
- (2) When internal combustion engine is installed, the following requirements are to be complied with.
 - (A) Oil fuel with a flashpoint of less than 43°C shall not be used.
 - (B) If air supply pipes or exhaust pipes, passing through pressure hull, are arranged, when diving, it shall be designed not to submerge without shutting off the closing valves.
 - (C) As the internal combustion engine do not operate after stopping the air suction, one of the following requirements shall be complied with.
 - (a) While operating the engine, the air supply pipes shall be designed not to shut off; or.
 - (b) When in board a barometer falls below its limitation, the engine shall automatically be shut down.
 - (D) The cooling sea water pipes shall not combined with other piping system. However, if the pipes are made to endure the related pressure under maximum diving depth, it may not be applied.

307. Electric Equipment

1. Electric equipment

The electric equipment of the tourist submersibles shall be complied with the following requirements as well as **Pt 6** of **Rules for the Classification of Steel Ships**.

- (1) All electric equipments are to be protected by sheath taking drip-proof construction at least IP 22.
- (2) For switch board and main power source, the shut off device shall be installed at the place to be easily accessible. However, the shut off device for main power source, when it is designed to be closed easily in emergency, is not to be applied.
- (3) The feeder circuit for propulsion, trim control and operating shall be so designed that their final sub-circuits are to be supplied by separating from the individual. And the circuits other than the above shall be so protected that the overload current and short-circuit current can not effect on the above circuits.
- (4) The charging facilities shall be provided. However, in the case of tourist submersibles with the support vessel or a restricted range of service, they can be supplied by the charging facilities fitted in the support vessel or at the shore.
- (5) Supply voltage of the electrical equipment shall not be more than DC 250 V. However, when there are the protective enclosure higher than degree of protection, decrease of the earth fault current having a possibility to occur, a fixed barrier, a doubled insulation, a protective diving suit, etc., the voltages more than 250 V may be permitted.

2. Battery

- (1) The battery shall be provided with a sufficient capacity on voyage and complied with the following requirements:
 - (A) insulating fully.
 - (B) not leaking out the liquid when a inclined condition is heeling and trim 15°, and pitching and rolling 60°.
 - (C) providing with the devices to monitor the charging condition.
- (2) When inside pressure hull a battery is provided, the following requirements are to be complied with.
 - (A) the battery is fitted at the place not getting influx of a bilge, and an appropriate action is to be taken to prevent the hydro gas from leaking.
 - (B) the monitoring devices for hydro gas shall be provided.

3. Cables

- (1) A cable passing through the pressure hull shall not fall off in the function, even if the tourist submersible operates under 2 times of a water pressure related to maximum diving depth. In the case of cables cut off, even though the tourist submersible operates under 1.5 times of a water pressure related to maximum diving depth, the watertightness shall be kept. And the cable conjunction shall be kept for the function and the watertightness.
- (2) For tourist submersible linked to a support vessel, when there are feeder cables getting the power from the support vessel, these cables are to be complied with;
 - (A) having the tensile strength and the watertightness sufficiently.
 - (B) considering not to be drawn into the bottom at sea.
 - (C) in emergency, fitting a detachable connection of cables inside pressure hull.

4. Lighting and lamplight

- (1) The lighting outside shall be water-proof type, and having a sufficient strength to endure a pressure related to maximum diving depth.
- (2) For safe controls of the tourist submersible, the lights needed for a pressure hull, even if one of the circuits in abnormal, shall be kept for lighting by other circuit.
- (3) The tourist submersible, after buoying on water, shall be provided with a proper lights or lamp-lights so that immediately be detected.

5. Earthing

An exposed non-conductor of electrical appliances and metal coverings of cables shall be effectively earthed.

308. Propulsion and Maneuvering Equipment

Propulsion and Maneuvering equipment for tourist submersible shall be complied with the requirements of **Pt 1, Ch 11** of the Rules.

309. Life Support Systems

1. General

- (1) The life support systems for tourist submersible shall be complied with the requirements of **Pt 1, Ch 14** of the Rules.
- (2) The life support systems shall be consisted of main life support system, auxiliary life support system, and emergency breathing apparatus, and separating from the individual respectively.
- (3) Main life support system shall have a sufficient capacity to keep all persons on board at least during designed maximum diving hours.
- (4) Auxiliary support system shall have a sufficient capacity to keep all persons on board at least 72 hours.
- (5) Auxiliary oxygen supply apparatus shall be made to operate at least 72 hours. However, if the following requirements are satisfied, it may be relieved to 24 hours ; when
 - (A) there is a support facility provided on water to intend for voyage, and possible for a diver to support within 1 hour.
 - (B) the tourist submersible is provided with two(2) of an emergency drop weight isolated and ballast equipments.
 - (C) there is a limitation to operate from the harbor less than 1 hour, and the maximum depth is possible for a diver to access.
 - (D) among ballasting in the tourist submersible, at least one of them shall be made for a diver to fill up the ballast tank manually outside the tourist submersible. And the manual ballast apparatus, even though maximum persons are on board, shall be made to ensure a sufficient buoyance after the ballasting.
 - (E) the final sea trial of the tourist submersible constructed shall be examined for the things such as the above under the attending surveyor.
 - (F) emergency evacuation plan including the above shall be reflected on the ship operating instruction.

- (6) Emergency breathing apparatus shall be complied with the following requirements:
 - (A) emergency oxygen supply apparatus is to be separated from main oxygen supply apparatus.
 - (B) when partial closed or opened breathing apparatus is provided, the device to control the pressure increasing shall be provided.
 - (C) emergency oxygen shall be fully provided to withstand during times, requiring hours from maximum diving depth to entirely buoying and adding 50 % of it under normal buoyance or two(2) hours, whichever is long.
 - (D) emergency breathing air shall be provided with contents of carbon dioxide not more than 1% of internal volume at 760 mmHg.
 - (E) As the number of maximum persons on board, one of the following masks shall be provided ;
 - (a) face protective type mask
 - (b) nose protective type mask
 - (c) self-contained breathing apparatus mask which capacity is more than (C).
 - (F) When the tourist submersible is complied with the following items, the above (C) and (E) are not to be applied ;
 - (a) the required time to open the hatch in buoying from maximum diving depth shall be less than 15 minutes.
 - (b) all passengers shall be provided with the anti-gas masks.
 - (c) all crews shall be provided with the self-contained breathing apparatus which can be used more than 15 minutes.
- (7) The carbon dioxide removing devices shall get the quantities to ensure that maximum persons on board can make a voyage at least 72 hours besides the operating times. However, when the requirements of the above, (6) (A) to (F) are complied with, 72 hours required may be relieved to 24 hours.
- (8) The tourist submersible shall be provided with a proper monitor and indicating devices complying with the following requirements.
 - (A) While diving, the internal pressure hull shall be provided with a proper devices to monitor and indicate the contents of oxygen and carbon dioxide and humidity.
 - (B) Besides the monitor and indicating devices of the above, the portable monitor and indicating devices or equivalent shall be provided at the passenger room on board.
 - (C) For the monitor and indicating devices of the above (A) and (B), when the contents of oxygen is 18 % to 23 %, or the carbon dioxide more than 0.5 %, the appropriate alarm may be done.
 - (D) The humidity inside the tourist submersible shall be always kept to 50 % \pm 20 %, and the humidity indicator shall be installed at the places to be confirmed under the voyage.
 - (E) The hydro monitoring devices shall be provided with the performance complied with the requirements of **Pt 1, Ch 14, 305**. of the Rules.

310. Moorings and Laying-up Equipments

1. General

- (1) The tourist submersible shall be provided with a proper equipments to moor it.
- (2) Anchors, Anchor Chains and Lopes shall be able to be contained on board
- (3) In the case of tourist submersibles with the support vessel or a restricted range of service, the equipments specified in the above (1) and (2) may be omitted.
- (4) When the balancing chains are provided, the detachable devices inside pressure hull at the maximum diving depth shall be provided. However, when the balancing chains are hindered from the obstacles, if in the position near the chains there is something to transmit the propulsion easily, it may be dispensed with.

311. Fire Protection and Fire Extinguishing

1. General

- (1) The fire protection and fire surveillance for a tourist submersible shall be complied with the requirements of **Pt 1, Ch 15, Sec 2 to Sec 3** of the Rules.
- (2) The fire extinguishing for a tourist submersible shall be complied with the requirements of **Pt 1, Ch 15, Sec 4** of the Rules.

312. Test

1. Inclining test

- (1) The tourist submersible, besides test specified in **101.** above, after completion of the all works, the inclining test shall be added.
- (2) On the basis of the results of inclining test, the particulars regarding to the safety performance shall be given to the operating instruction specified in the above **104.**

2. Sea trial

- (1) The sea trial of the tourist submersible shall be taken at the maximum diving depth.
- (2) Before the sea trial, the plan shall be submitted to the Society, and if needed by the Society, an additional test shall be carried out. ↓

Annex 1 Calculation and Pressure Hulls under External Pressure

1. General

1.1 Design and Calculation

- (1) A method of calculation for designing the pressure hulls of submersibles is described below, which can be used for the three loading conditions:
 - (A) nominal diving pressure P_N
 - (B) test pressure P_P
 - (C) collapse pressure P_Zto investigate the stresses in the pressure hull and the corresponding states of stability:
 - (D) asymmetric buckling between stiffeners (axial bucking)
 - (E) symmetric buckling between stiffeners (circular bucking)
 - (F) general instability of pressure hull design
 - (G) tripping of ring stiffeners
 - (H) buckling of dished ends
- (2) The method of calculation presented takes limited account of fabrication relevant deviations from the ideal shape of the shell (out-of-roundness). Methods of verifying the roundness of hull shells are also described.
- (3) Conical shells are calculated in sections, each of which is treated as a cylindrical shell.
- (4) Overall collapse of the design is regarded as buckling of the hull structure between bulkheads or dished ends.
- (5) With regards to the stresses in the pressure hull the permissible values are those stated in **Pt 1, Ch 5, Sec 5** of the Rules.
- (6) For the states of stability described, proof is required of sufficient safety in respect of the particular form of damage concerned.
- (7) When using the method of calculation it is to be remembered that both elastic and elastic-plastic behaviour can occur in the materials of the shell structure. It is generally the case that
 - (A) at nominal diving pressure, the stress is within the purely elastic range of the material; However, calculations relating to the permissible stress being exceeded can be based on the assumption that the behaviour of the material is elastic.
 - (B) at the collapse pressure, the stress may lie in the elastic or the elastic-plastic range of the material.
- (8) In the elastic-plastic range, use of the method requires the determination of value by a process of iteration. The modulus of elasticity E and the Poisson's ratio ν shall be submitted by the values E' and ν' according to **7**.

2. Stiffened and unstiffened Cylindrical Shells

2.1. General

- (1) For the loading conditions mentioned in **1.1 (1)**. Cylindrical shells are to be checked for excess stresses and asymmetric and symmetric buckling.
- (2) The method of calculation presented below is for stiffened cylindrical shells. In the case of unstiffened cylindrical shells with dished ends, the calculations are performed in a similar manner, the cross-sectional area of the ring stiffener being $A = A_1 = 0$ and the spacing between stiffeners being defined by the ends. Where the spacing between stiffeners is defined by dished ends 40% of the depth H of each dished end is to be added to the cylindrical length (see **Fig. 1.1**).

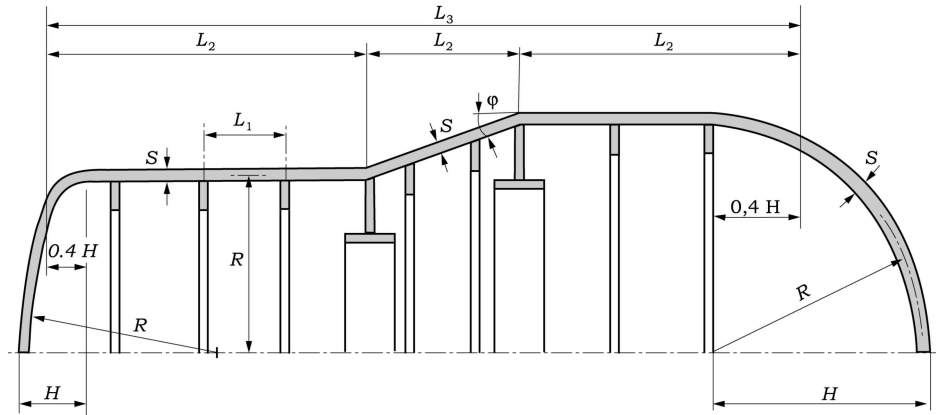

Fig. 1.1

- (3) For the calculation of buckling in the elastic-plastic range the modulus of elasticity E and the poisson's ν is determined by applying formulae (65)–(68) and by means of the stress σ_i formula (1) in the centre of the section and the centre of the plate.
- (4) The calculations allow for an out-of-roundness of the shell of maximum $\mu = 0.005$. If larger tolerances are planned, or if the method of measurement described in **8.1** results in greater out-of-roundness values, then the permissible pressure is to be checked in accordance with **8.2**

2.2 Stresses in the cylindrical shell

The stress intensity (at the centre of the plate at midway position between ring stiffeners) is determined by applying formulae (1)–(14). In formulae (2a)–(2d) the centre of the bending component is expressed by the plus sign on top for the outside of the cylindrical shell and by the minus sign below for the inside. The stresses in the centre of the plate are determined by omitting of the expression after the plus/minus signs.

$$\sigma_i = \sqrt{\sigma_x^2 + \sigma_\phi^2} - \sigma_x \times \sigma_\phi \quad (1)$$

$$\sigma_0 = -\frac{p \times P}{s} \quad (2)$$

In the centre of the section the following applies:

$$\sigma_x = \sigma_0 \left(\frac{1}{2} \pm C_{10} \times C_{11} \times F_4 \right) \quad (2a)$$

$$\sigma_\phi = \sigma_0 (1 - C_{10} \times F_2 \pm \nu \times C_{10} \times C_{11} \times F_4) \quad (2b)$$

In the area of stiffening the following applies:

$$\sigma_x = \sigma_0 \left(\frac{1}{2} \pm C_{10} \times C_{11} \times F_3 \right) \quad (2c)$$

$$\sigma_\phi = \sigma_0 (1 - C_{10} \pm \nu \times C_{10} \times C_{11} \times F_3) \quad (2d)$$

$$F_1 = \frac{4}{C_s} \left[\frac{\cosh^2 C_8 - \cos^2 C_9}{\frac{\cosh C_8 \times \sinh C_8}{C_6} + \frac{\cos C_9 \times \sin C_9}{C_7}} \right] \quad (3a)$$

$$F_2 = \left[\frac{\frac{\cosh C_8 \times \sin C_9}{C_7} + \frac{\sinh C_8 \times \cos C_9}{C_6}}{\frac{\cosh C_8 \times \sinh C_8}{C_6} + \frac{\cos C_9 \times \sin C_9}{C_7}} \right] \quad (3b)$$

$$F_3 = \sqrt{\frac{3}{1-\nu^2}} \left[\frac{-\frac{\cosh C_8 \times \sinh C_8}{C_6} + \frac{\cos C_9 \times \sin C_9}{C_7}}{\frac{\cosh C_8 \times \sinh C_8}{C_6} + \frac{\cos C_9 \times \sin C_9}{C_7}} \right] \quad (3c)$$

$$F_4 = \sqrt{\frac{3}{(1-\nu^2)}} \left[\frac{\frac{\cosh C_8 \times \sin C_9}{C_7} + \frac{\sinh C_8 \times \cos C_9}{C_6}}{\frac{\cosh C_8 \times \sinh C_8}{C_6} + \frac{\cos C_9 \times \sin C_9}{C_7}} \right] \quad (3d)$$

$$A = A_1 \times \frac{R^2}{R_0^2} \quad (4)$$

$$C_5 = \alpha \times L_1 \quad (5)$$

$$C_6 = \frac{1}{2} \sqrt{1-C} \quad (6)$$

$$C_7 = \frac{1}{2} \sqrt{1+C} \quad (7)$$

$$C_8 = C_5 \times C_6 \quad (8)$$

$$C_9 = C_5 \times C_7 \quad (9)$$

$$C_{10} = \frac{\left(1 - \frac{\nu}{2}\right) \times \frac{A}{s \times L_1}}{\frac{A}{s \times L_1} + \frac{b}{L_1} + \left(1 - \frac{b}{L_1}\right) F_1} \quad (10)$$

$$C_{11} = \sqrt{\frac{0.91}{1-\nu^2}} \quad (11)$$

$$P^* = \frac{2 \times s^2 \times E}{R^2 \times \sqrt{3} \times (1-\nu^2)} \quad (12)$$

$$G = \frac{P}{P^*} \quad (13)$$

$$\alpha = \sqrt[4]{\frac{3 \times (1 - \nu^2)}{s^2 \times R^2}} \quad (14)$$

$$K_0 = \frac{\sigma_\phi}{\sigma_x} \quad (15)$$

where,

A : modified area of stiffener ring (mm^2)

A_1 : cross-sectional area of stiffener ring (mm^2)

L_1 : spacing between two "light" stiffeners (mm)

b : width of stiffener ring in contact with shell (mm)

α : shape factor (1/mm)

σ_i : stress intensity (N/mm^2)

σ_0 : stress (calculate value) (N/mm^2)

σ_ϕ : stress in circumferential direction (N/mm^2)

σ_x : stress in longitudinal direction (N/mm^2)

ν : Poisson's ratio (elastic)

R_0 : radius of stiffener ring centroid including effective length

R : mean radius of wall

G : pressure ratio

E : modulus of elasticity

P : external design pressure (N/mm^2)

P^* : critical pressure (N/mm^2)

K_0 : stress ratio

$C_5 \sim C_{11}$: calculation factor for stress in cylindrical shell

2.3 Provision against excess stresses

The stress intensity for the three loading conditions is contained from formula (1). Sufficient safety against exceeding the permissible stress is provided if the conditions (16a,b,c) are met. In formulae (2a) to (2d) where load $P = P_Z$ the binding component can be disregarded.

$$k \geq \sigma_i \times S \quad (\text{where } P = P_N) \quad (16a)$$

$$k \geq \sigma_i \times S' \quad (\text{where } P = P_P) \quad (16b)$$

$$k \geq \sigma_i \quad (\text{where } P = P_Z) \quad (16c)$$

where,

k : yield strength R_{eH20} (N/mm^2)

S : safety factor applied to yield strength R_{eH20} at nominal pressure

S' : safety factor applied to yield strength R_{eH20} at test diving pressure

P_N : nominal diving pressure (1st load condition) (N/mm^2)

P_P : test diving pressure (2nd load condition) (N/mm^2)

P_Z : collapse pressure (3rd load condition) (N/mm^2)

2.4 Asymmetric buckling

The buckling pressure P_n is calculated with formulae (17)–(19) for the integer value $n \geq 2$ corre-

sponding to the lowest value of P_n . The relevant stresses of the centre of the plate are determined in accordance with 2.2

$$P_n = \frac{E \times s \times \beta_{n1}}{R} \quad (17)$$

$$\beta_{n1} = \left[\frac{\left(\frac{n^2}{\lambda_1^2} + 1 \right)^{-2} + \frac{s^2 \times (n^2 - 1 + \lambda_1^2)^2}{12 \times R^2 \times (1 - \nu^2)}}{(n^2 - 1 + 0.5 \lambda_1^2)} \right] \quad (18)$$

$$\lambda_1 = \frac{\pi \times R}{L_1} \quad (19)$$

where,

P_n : buckling pressure, asymmetric buckling (N/mm²)

L_1 : spacing between two "light" stiffeners (mm)

λ_1 : coefficient

β_{n1} : coefficient

s : thickness of shell/sphere without abrasion and corrosion (mm)

2.5 Prevision against asymmetric buckling

The buckling pressure for the three loading conditions is obtained from formula (17). Sufficient safety against asymmetric buckling is provided if the conditions (20a,b,c) are met.

$$P_n \geq P_N \times S_k \quad (\text{for the nominal diving pressure load condition}) \quad (20a)$$

$$P_n \geq P_P \times S'_k = P_N \times S_1 \times S'_k \quad (\text{for the test diving pressure load condition}) \quad (20b)$$

$$P_n \geq P_Z = P_N \times S_2 \quad (\text{for the collapse pressure load condition}) \quad (20c)$$

where,

S_k : safety factor against instability at nominal pressure

S'_k : safety factor against instability at test diving pressure

2.6 Symmetric buckling

The buckling pressure P_m is calculated with formulae (21)–(33) and ((15) for the lowest integer value of m at which conditions (33) is met. The values E_s and E_t are determined in accordance with 7. The relevant stresses if the centre of the plate are calculated in accordance with 2.2. In the elastic range $E_s = E_t = E$ and $\nu' = \nu$.

$$P_m = P^{**} C_0 \left[\left(\frac{\alpha_1 L_1}{\pi m} \right)^2 + \frac{1}{4} \left(\frac{\pi m}{\alpha_1 L_1} \right)^2 \right] \quad (21)$$

$$P^{**} = \frac{2 s^2 E_s}{R^2 \sqrt{3(1 - \nu'^2)}} \quad (22)$$

$$C_0 = \sqrt{\frac{C_1 C_2 - \nu'^2 C_3^2}{1 - \nu'^2}} \quad (23)$$

$$C_1 = 1 - \frac{H_2^2 H_4}{H_1} \quad (24)$$

$$C_2 = 1 - \frac{H_3^2 H_4}{H_1} \quad (25)$$

$$C_3 = 1 - \frac{H_2 H_3 H_4}{\nu' H_1} \quad (26)$$

$$H_1 = 1 + H_4 [H_2^2 - 3(1 - \nu'^2)] \quad (27)$$

$$H_2 = (2 - \nu') - (1 - 2\nu') K_0 \quad (28)$$

$$H_3 = (1 - 2\nu') - (2 - \nu') K_0 \quad (29)$$

$$H_4 = \frac{1 - \frac{E_t}{E_s}}{4(1 - \nu'^2) K_1} \quad (30)$$

$$K_1 = 1 - K_0 + K_0^2 \quad (31)$$

$$\alpha_1 = \sqrt{\frac{3 \left\{ \frac{C_2}{C_1} - \nu' \left(\frac{C_3}{C_1} \right)^2 \right\}}{s^2 R^2}} \quad (32)$$

$$\frac{\alpha_1 L_1}{\pi} \leq \sqrt{\frac{m}{2} (m+1)} \quad (33)$$

where,

P_m : buckling pressure, symmetric (N/mm²)

P^{**} : critical pressure, elastic-plastic (N/mm²)

$H_1 \sim H_4$: calculation factors for symmetric buckling

E_s : secant modulus

2.7 provisions against symmetric buckling

The buckling pressure P_m for the collapse pressure condition is obtained from formula (21). Sufficient safety against symmetric buckling is provided if the conditions (34a,b,c) are met.

$$P_m \geq P_N \times S_k \text{ (for the nominal diving pressure load condition)} \quad (34a)$$

$$P_m \geq P_P \times S_k' = P_N \times S_1 \times S_k' \text{ (for the test diving pressure load condition)} \quad (34b)$$

$$P_m \geq P_Z = P_N \times S_2 \text{ (for the collapse pressure load condition)} \quad (34c)$$

3. Ring Stiffeners

3.1 General

(1) It is the purpose of ring stiffeners to reduce the buckling length of cylindrical shells. A dis-

inction is made between "heavy" and "light" ring stiffeners. "Heavy" ring stiffeners are stiffeners which are able to reduce the significant mathematical length of the pressure hull as this relates to the failure described in 3.2 (3) The dimensions of "heavy" stiffeners are not to be smaller than the "light" stiffeners. (see Fig. 1.2)

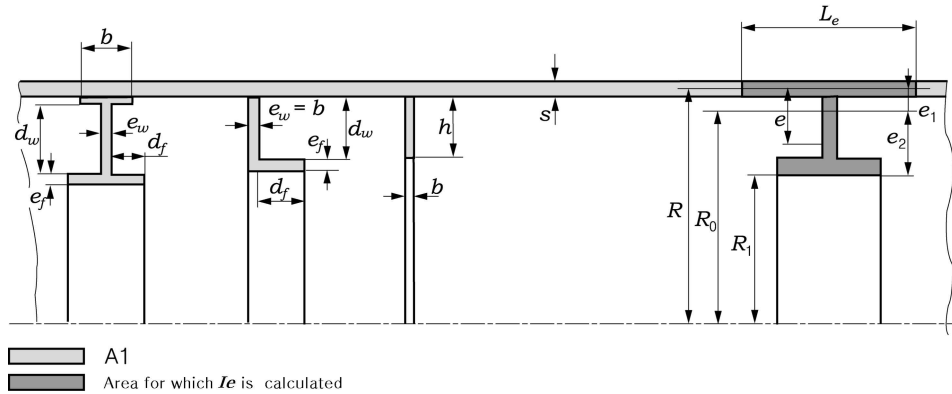

Fig 1.2 Stiffeners

- (2) For a terminal section, the length to be used is that between the end and the stiffener. (In the case of dished ends, the buckling length is to take account of the instruction in 2.1 and Fig. 1.1) For the loading conditions mentioned (1), stiffeners are to be designed for safety against excess stresses, buckling and tripping. Unreinforced cut-outs in the girth or web are to be considered for calculation.

3.2 "Light" stiffeners

- (1) Stresses in "light" stiffeners

The stresses are calculated using formulae (4), (14), (35)–(37) and the values of P_{n1} and n according to 3.2 (3) If $n=2$ determined also $n=3$ has to be calculated. In formulae (37), $L=L_1$. Where the distances L_1 to the two adjoining stiffeners are unequal, the calculation shall make use of the arithmetic mean value of both distances. in the elastic–plastic range the value E and ν are replaced by E' and ν' respectively. The elasticity modulus E' and the Poisson's ratio ν' are calculated in accordance with 7. in relation to stress σ_f .

$$\sigma_f = \frac{p R^2 \left(1 - \frac{\nu}{2}\right)}{R_1 \left[s + \frac{A}{b + \frac{2N}{\alpha}} \right]} \quad (35)$$

$$\sigma_{fb} = \pm \frac{p(n^2 - 1) E e_2 U}{(P_n - P) R_0^2} \quad (36)$$

$$N = \frac{\cosh(\alpha L) - \cos(\alpha L)}{\sinh(\alpha L) - \sin(\alpha L)} \quad (37a)$$

$$N = 1 \quad \text{for } \alpha \times L > 5.5 \quad (37b)$$

where,

σ_f : compression stress in girth (N/mm²)

σ_{fb} : bending stress in girth (N/mm²)

(2) Provision against excess stresses

For the three loading conditions, formulae(35) and (36) give the stresses σ_f and σ_{fb} , the absolute values of which are related to the yield strength k in conditions (38a,b,c)

$$k \geq |\sigma_f| \times S + |\sigma_{fb}| \times S_k \quad (\text{for } P = P_N) \quad (38a)$$

$$k \geq |\sigma_f| \times S' + |\sigma_{fb}| \times S_k' \quad (\text{for } P = P_P) \quad (38b)$$

$$k \geq |\sigma_f| + |\sigma_{fb}| \quad (\text{for } P = P_Z) \quad (38c)$$

(3) Buckling

The "light" stiffeners are to be calculated using formulae (39)–(45) for the integer $n \geq 2$ which produces the lowest value of P_{n1} . In formulae (41) $L = L_2$, and, in the absence of "heavy" stiffeners, $L = L_3$. In the elastic-plastic range, E' according to **7**, is to be substituted for E in formulae (39) and (42). The necessary stress calculation is performed in accordance with **3.2**. (1)

$$P_0 = \frac{Es \beta_{n2}}{R} \quad (39)$$

$$\beta_{n2} = \frac{\lambda_2^4}{(n^2 - 1 + 0.5\lambda_2^2)(n^2 + \lambda_2^2)^2} \quad (40)$$

$$\lambda_2 = \frac{\pi R}{L} \quad (41)$$

$$P_1 = \frac{(n^2 - 1) E I_e}{R_0 + L_1} \quad (42)$$

$$P_{n1} = P_0 + P_1 \quad (43)$$

$$I_e = \frac{A_1 e^2}{1 + \frac{A_1}{L_e s}} + I_1 + \frac{L_e s^3}{12} \quad (44)$$

$$L_e = \sqrt{2R_s + b} \quad (45a)$$

In addition with light stiffeners

$$L_e \leq L_1 \quad (45b)$$

where,

L_e : effective length of shell

β_{n2} : coefficient

λ_2 : coefficient

P_{n1} : buckling pressure, asymmetric buckling "light" stiffener

(4) Provision against buckling

The calculation of the buckling pressure P_{n1} for the three loading conditions is performed in accordance with **3.2** (3) Sufficient safety against buckling is provided if the conditions (46a,b,c) are met

$$P_{n1} \geq P_N \times S_k \quad (\text{for the nominal diving pressure load condition}) \quad (46a)$$

$$P_{n1} \geq P_p \times S'_k = P_N \times S_1 \times S'_k \quad (\text{for the test diving pressure load condition}) \quad (46b)$$

$$P_{n1} \geq P_Z = P_N \times S_2 \quad (\text{for the collapse pressure load condition}) \quad (46c)$$

3.3 "Heavy" stiffeners

(1) Stresses in "heavy" stiffeners

The stresses are calculated using formulae (35)–(37) and the values P_g and n according to 3.3 (3). In formulae (37) and (41) $L=L_2$. If the distances L_2 to the two adjoining stiffeners (or ends) are unequal, the calculation shall make use of the arithmetic mean value of both distances. In the elastic–plastic range the values E and ν are replaced by E' and ν' . The elasticity modulus E' and the Poisson's ratio ν' are calculated in accordance with 7. in the relation to the stress σ_f .

(2) Provision against excess stresses

For the three loading conditions, formulae (35) and (36) give the stresses σ_f and σ_{fb} , the absolute values of which are related to the yield strength k in conditions (38a,b,c)

(3) Buckling (general stability)

Using formulae (39)–(42) and (47)–(49), the overall stability of the design is to be calculated for the integer $n \geq 2$ at which the buckling pressure P_g attains its lowest value. The calculation factor C_4 in formulae (47) becomes $C_4 = -4$ for internal stiffeners and $C_4 = n^2$ for external stiffeners. Where only one "heavy" stiffener is located midway between two bulkheads, the total buckling pressure P_g formulae (49) can be increased by a membrane stress element P_0 in accordance with formulae (39)–(41) where $L=L_3$. Where there are no "heavy" stiffeners, the buckling P_g is obtained from formula (43)

$$P_g = P_{n1}$$

$$P_2 = \frac{(n^2 - 1)EI_e}{R_0^2(R + e_1 C_4)L_2} \quad (47)$$

$$P_{n2} = \frac{P_0 \times P_2}{P_0 + P_2} \quad (48)$$

$$P_g = P_1 + P_{n2} \quad (49)$$

(4) Provision against buckling

The calculation of the total buckling pressure P_g for the three loading conditions is performed in accordance with 3.3.3 Sufficient safety against buckling is provided if the conditions (50a,b,c) are met.

$$P_{g1} \geq P_N \times S_k \quad (\text{for the nominal diving pressure load condition}) \quad (50a)$$

$$P_{g1} \geq P_p \times S'_k = P_N \times S_1 \times S'_k \quad (\text{for the test diving pressure load condition}) \quad (50b)$$

$$P_{g1} \geq P_Z = P_N \times S_2 \quad (\text{for the collapse pressure load condition}) \quad (50c)$$

3.4 Tripping of ring stiffeners.

(1) Tripping pressure and general conditions

The tripping pressure P_k of flat bar stiffeners is to be calculated using formulae (4), (14), (37) and (51) and Fig. 1.3 or 1.4. The value of n is to be that used in 3.2 (3) or 3.3 (3) for calculations in the elastic–plastic range, E and ν in the aforementioned formulae are to be replaced by E' and ν' in accordance with 7. The necessary stress calculation is performed in accordance with 3.2 (1) or 3.3 (1) The maximum allowable value of $k_1/E(hb)^2$ is 1.14 in each case. Calculation of the tripping pressure using the formulae referred to above necessitates maintaining the tolerances stated in 9.

$$P_k = \frac{k_1 R_1}{R_2 \left(1 - \frac{\nu}{2}\right)} \left(s + \frac{A}{b + \frac{2N}{\alpha}} \right) \quad (51)$$

(2) Resistance of tripping

For flat bar stiffeners, the tripping pressure P_k for the three loading conditions is obtained from formula (51). Sufficient resistance to tripping is provided if the conditions (52a,b,c) are met

$$P_{k1} \geq P_N \times S_k \quad (\text{for the nominal diving pressure load condition}) \quad (52a)$$

$$P_{k1} \geq P_P \times S'_k = P_N \times S_1 \times S'_k \quad (\text{for the test diving pressure load condition}) \quad (52b)$$

$$P_{k1} \geq P_Z = P_N \times S_2 \quad (\text{for the collapse pressure load condition}) \quad (52c)$$

Proof of the sufficient resistance to tripping of L -, T - and I -section stiffeners can be provided by applying formulae (53). Proof can be dispensed with if minimum seven of the following eight conditions are met:

$$e_W \geq s, e_f \geq e_W, e_f \leq 2s, d_W \leq 20e_W, d_W \leq \frac{R}{2}, d_f \leq 10e_f, \frac{d_W}{2} \geq d_f \geq \frac{d_W}{4}, k S_k \leq \frac{E I'_1}{A_1 R e} \quad (53)$$

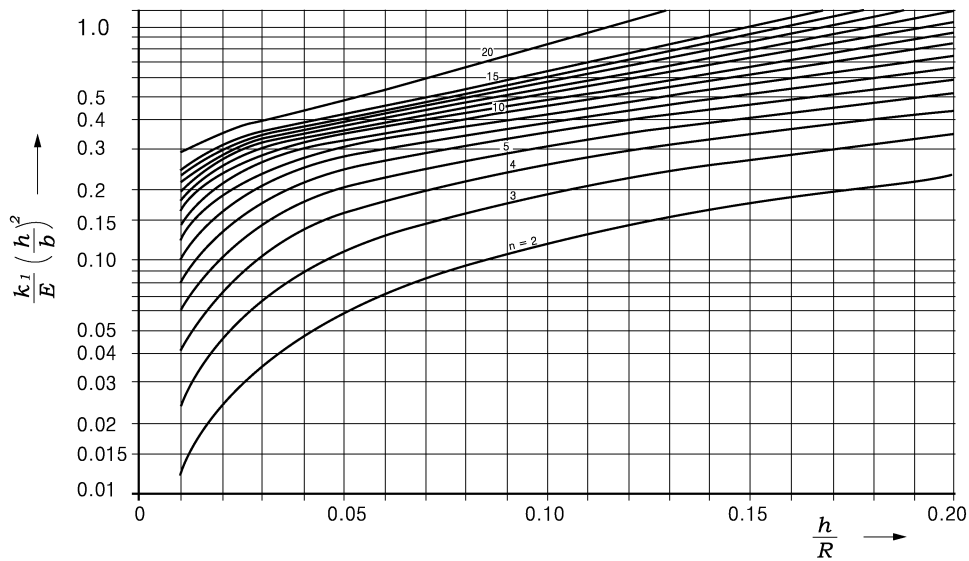

Fig 1.3

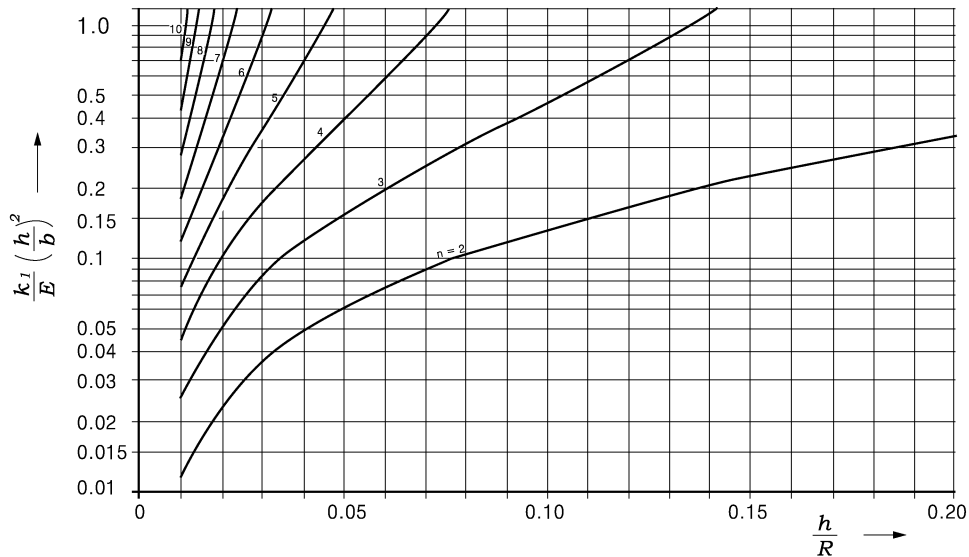

Fig 1.4

4. Stiffened and Unstiffened Conical Shells

The procedure to be applied to conical shells is similar to that for cylindrical shells. Conical shells are replaced in sections by cylinders having the mean diameter and by multiplying the actual external pressure by $1/\cos\phi$. It is assumed that the ends of the cone are fitted with "heavy" ring stiffeners. If not, a stress analysis has to be performed in accordance with 6.1. Ring stiffeners are to be calculated in the manner described in 3. The instructions given in 2.1 are applicable to out-of-roundness values in conical shells.

5. Dished Ends and Spheres

5.1 General

Dished ends and spheres are to be examined for excess stresses and buckling under the loading conditions stated in 1. In the case of dished ends, the stresses in the crown radius and in knuckle radius are to be investigated. Spheres are to be treated in the same way as the crown radius of dished ends. The calculation allow for out-of-roundness of the shell up to a maximum of $\mu = 0.04 \times s/R$. If larger tolerances are planned, or if the method of measurement described in 8.3 results in greater out-of-roundness values, then the permissible pressure is to be checked in accordance with 8.4.

5.2 Stress

For the dished sections the stress is obtained by applying formulae (54). For the knuckle radius the stress is obtained with formulae (55), the radius R being the radius of the adjoining cylindrical jacket. The coefficient β are to be taken from Fig. 1.5. For hemispherical ends in the range of $0.5\sqrt{s \cdot R}$ beside the transition to the cylinder a coefficient $\beta = 1.1$ is valid.

$$\sigma = -\frac{Rp}{2s} \quad (54)$$

$$\sigma = -\frac{pR1.2\beta}{2s} \quad (55)$$

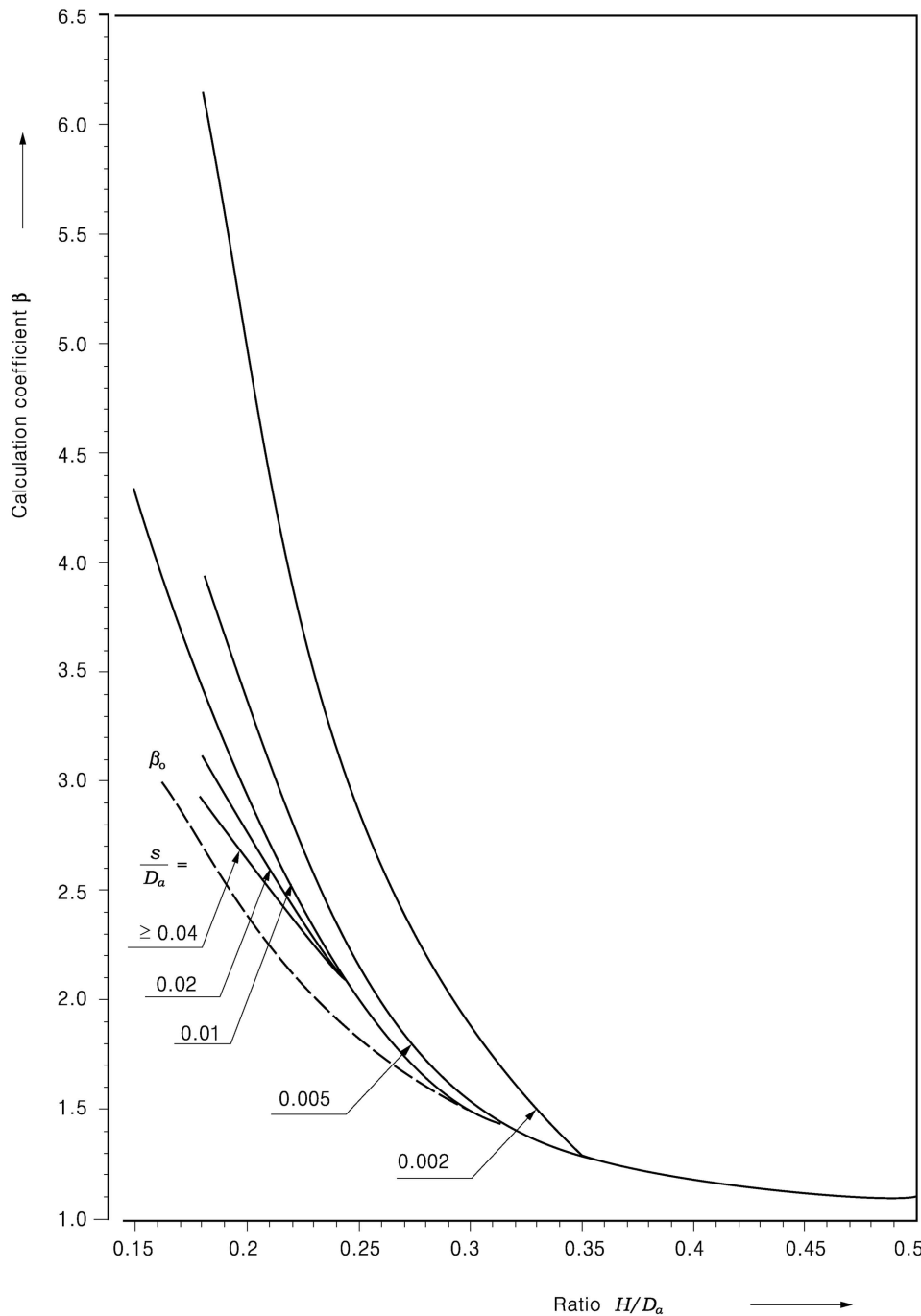

Fig 1.5

5.3 Provision against excess stresses

The stress for the three loading conditions is obtained by applying formulae (54) and (55). Sufficient safety against excess stresses is provided if the conditions (56a,b,c) are met, allowing for the absolute values of σ

$$k \geq |\sigma| \times S \text{ (for } P = P_N \text{)} \tag{56a}$$

$$k \geq |\sigma| \times S' \text{ (for } P = P_P \text{)} \tag{56b}$$

$$k \geq |\sigma| \text{ (for } P = P_Z \text{)} \tag{56c}$$

5.4 Buckling

The buckling pressure P_n in the dished section for the nominal diving pressure and test diving pressure load conditions is determined by applying formula (57)

$$P_n = 0.366 E \left(\frac{s}{R} \right)^2 \quad (57)$$

The buckling pressure P_n in the dished section for the collapse pressure load condition is calculated with formula (58). The elasticity moduli E_s and E_t are calculated in accordance with 7. allowing for the stress determined with formula (54)

$$P_n = 0.84 \sqrt{E_s E_t} \left(\frac{s}{R} \right)^2 \quad (58)$$

5.5 Provision against buckling

The buckling pressure for the nominal diving pressure and test diving pressure load conditions is calculated with formula (57). Sufficient safety is provided if the conditions (59a,b) are met. The buckling pressure for the collapse pressure load condition is calculated with formula (58). Sufficient safety is provided if conditions (59c) is met.

$$P_n \geq P_N \times S_k \quad (\text{for the nominal diving pressure load condition}) \quad (59a)$$

$$P_n \geq P_P \times S_k' = P_N \times S_1 \times S_k' \quad (\text{for the test diving pressure load condition}) \quad (59b)$$

$$P_n \geq P_Z = P_N \times S_2 \quad (\text{for the collapse pressure load condition}) \quad (59c)$$

6. Opening and Discontinuities

6.1 Discontinuities

Discontinuities such as

- Connections between cylinders and conical segments
- Reinforcing rings (rings other than the ring stiffeners dealt with in 3)
- Flanges for fixing spherical shell windows

must be subjected to a stress and elongation analysis similar to that specified in **ASME Boiler Pressure Vessel Code, Division 2, Section, 1989** for the nominal diving pressure and test diving pressure load conditions. The comparison stress is determined by applying formula (1). Sufficient safety is provided if the conditions (16a,b) are met. In case of an interruption of stiffeners an adequate reinforcing has to be provided.

6.2 Cylinder/cylinder penetrations

Cutouts in cylinders are to be made in accordance with the relevant requirements of **Pt 5, Ch 5, Sec 3 of Rules for the Classification of Steel Ships** and using as internal pressure a design pressure P_c calculated by applying formulae (60)–(61) – minimum with the relevant pressure of the load case. Reinforcements are to be provided as integral reinforcements.

$$P_c = \frac{2P_N^2 \times R \times S}{k \times F \times s_A} \quad (60a)$$

$$P_c = \frac{2P_p^2 \times R \times S'}{k \times F \times s_A} \quad (60b)$$

$$P_c = \frac{2P_z^2 R}{k F s_A} \quad (60c)$$

$$F = 1 + 3\mu \left(1 - \frac{0.4R}{L_1} \right) \frac{R}{s_A} \quad \left(\text{for } \frac{L_1}{R} \geq 0.4 \right) \quad (61a)$$

$$F = 1 \quad \left(\text{for } \frac{L_1}{R} < 0.4 \right) \quad (61b)$$

6.3 Sphere/ cylinder penetrations

Cutouts in spheres are to be made in accordance with the relevant requirements of **Pt 5, Ch 5, Sec 3** of **Rules for the Classification of Steel Ships** and using as internal pressure an increased design pressure P_c calculated by applying formulas (62)

$$P_c = 1.2 \times P_N \quad (62a)$$

$$P_c = 1.2 \times P_P \quad (62b)$$

$$P_c = 1.2 \times P_Z \quad (62c)$$

7. Elasticity Moduli

The elasticity modulus for calculations in the elastic region up to the limit of proportionality is to be taken from the standard specifications for the materials concerned. For design temperature up to 5 0°C, a value of $E = 206,000 \text{ N/mm}^2$ can generally be accepted for ferritic steels. For steel, a Poisson's ratio of $\nu = 0.3$ is to be used. In the elastic-plastic range, the elasticity moduli E_s and E_t for steel between the limit of proportionality σ_e and the yield point k according to the stress-strain curve $\sigma = f(\epsilon, k, E)$ are to be determined by applying formulae (63)–(66)

$$z = \frac{\sigma_e}{k}$$

$$\sigma = k \left[z + (1-z) \operatorname{tgh} \left(\frac{E \times \epsilon}{(1-z)k} - \frac{z}{(1-z)} \right) \right] \quad (63)$$

$$\epsilon = \frac{k}{E} \left[z + (1-z) \operatorname{artgh} \left(\frac{\sigma}{(1-z)k} - \frac{z}{(1-z)} \right) \right] \quad (64a)$$

$$\epsilon_{\min} = z \frac{k}{E} \quad (64b)$$

$$\epsilon_{\min} = \operatorname{Min} \left[\text{maximum remaining elongation} + \frac{k}{E}, \epsilon = f(\sigma \rightarrow k) \right] \quad (64c)$$

$$E_s = \frac{k}{\epsilon} \left[z + (1-z) \operatorname{tgh} \left(\frac{E}{(1-z)k} - \frac{z}{1-z} \right) \right] \quad (65)$$

$$E_t = E \left[1 - \operatorname{tgh}^2 \left(\frac{E \times \epsilon}{(1-z)k} - \frac{z}{(1-z)} \right) \right] \quad (66)$$

For calculations in the elastic-plastic range which were originally developed for the elastic range, the term E is to be replaced by the term E' from formula (67)

$$E' = \sqrt{E_s \times E_t} \quad (67)$$

With the Society's agreement, the stress-strain curve actually measured may be used to determine the elasticity moduli in the elastic-plastic range. In the elastic-plastic range, the Poisson's ratio is to be calculated using formula (68)

$$\nu' = \frac{1}{2} - \left(\frac{1}{2} - \nu \right) \frac{E_s}{E} \quad (68)$$

8. Out-of-Roundness of cylinders and Spheres

Cylindrical shells and dished ends subjected to external pressure are to be checked for out-of-roundness. If the tolerances are exceeded, the permissible external pressure is to be reduced to the value P' .

8.1 Measuring the out-of-roundness of cylindrical shells

The number of planes used for measuring the out-of-roundness of cylindrical pressure vessels is to be agreed with the Society. For each plane, the number of measuring prints (J) shall be at least 24, and these shall be evenly distributed round the circumference. The height of arc $x(j)$ is measured with a bridge extending over a string length $y = 4 \cdot \pi \cdot (R + s/w)/J$ (cf. Fig. 1.6). From the values $x(j)$ and the influence coefficients C , the out-of-roundness values can be calculated by applying formula (69). Table 1 gives the influence coefficients C where $J=24$. If the out-of-roundness $U(j)$ at any measuring point exceeds a value of $U = 0.005 \times R$, then a reduced permissible pressure P' is to be determined in accordance with 8.3

Table 1 Influence factor C_i where $J=24$

$i-j$	C_{i-j}	$i-j$	C_{i-j}
0	1.76100	12	0.60124
1	0.85587	13	0.54051
2	0.12834	14	0.36793
3	-0.38800	15	0.11136
4	-0.68359	16	-0.18614
5	-0.77160	17	-0.47097
6	-0.68487	18	-0.68487
7	-0.47097	19	-0.77160
8	-0.18614	20	-0.68359
9	0.11136	21	-0.38800
10	0.36793	22	0.12834
11	0.54051	23	0.85587

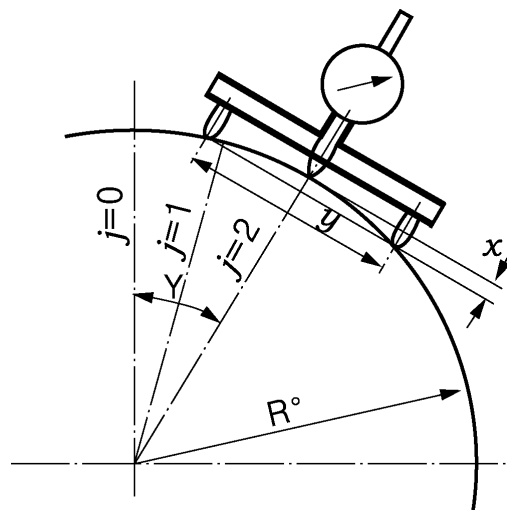

Fig 1.6

$$U_j = \sum_{i=0}^{j-1} x_i C_{|i-j|} \quad (69)$$

Example of the out-of-roundness U at measuring point $j = 2$ where $j = 24$

$$U_2 = x_0 \times C_2 \times x_1 \times C_1 + x_2 \times C_0 \times x_3 \times C_1 + \dots + x_{21} \times C_{19} \times x_{22} \times C_{20} + x_{23} \times C_{21}$$

8.2 Calculation of permissible pressure for cylindrical shell with an out-of-roundness $u > 0.005$

The bending stress is determined for all measuring points by the choice of a reduced permissible pressure P' and by applying formula (70). The total stress is found with formula (74) and the reduced permissible pressure P' with formula (75) by a process of iteration, the n -related value for formula (17) being substituted for the pressure P_n . The mean radius R' is to be determined by measuring the circumference.

$$\sigma_b = \frac{E \times s}{2R^2(1-\nu^2)} \sum_{n=2}^{J/2} \left\{ (n^2-1) + \nu \left(\frac{\pi R}{L_1} \right)^2 \right\} \times \left\{ \frac{P'}{P_n - P'} \right\} \{ a_n \sin(n\gamma) + b_n \cos(n\gamma) \} \quad (70)$$

$$\gamma = \frac{2\pi}{J} i \quad (71)$$

$$a_n = \frac{2}{J} \sum_{i=0}^{J-1} (R' + U_i) + \sin(n\gamma) \quad (72)$$

$$b_n = \frac{2}{J} \sum_{i=0}^{J-1} (R' + U_i) + \cos(n\gamma) \quad (n = \frac{J}{2}) \quad (73a)$$

$$b_n = \frac{1}{J} \sum_{i=0}^{J-1} (R' + U_i) + \cos(n\gamma) \quad (n = \frac{J}{2}) \quad (73b)$$

$$k \geq \frac{P'R}{s} + \sigma_b \quad (74)$$

$$P' \geq \frac{P'}{S} + \left(p - \frac{P'}{S} \right) \frac{0.005R}{U_{\max}} \quad (75)$$

8.3 Measuring the out-of-roundness of spheres

The height of arc x' is measured with a bridge gauge (cf. **Fig. 1.7**), the string length y being calculated with formulae (76) and (79). The out-of-roundness U is determined with formula (78). If the out-of-roundness is greater than $u = 0.04 \cdot s/R$, a reduced permissible pressure P' is to be determined in accordance with **8.4**

$$y = 2 \left(R + \frac{s}{2} \right) \sin \delta \quad (76)$$

$$y = \left(R + \frac{s}{2} \right) (1 - \cos \delta) \quad (77)$$

$$U = x - x' = uR \quad (78)$$

$$\delta = \frac{1.1}{(1-\nu^2)} \sqrt{\frac{s}{\left(R + \frac{s}{2} \right)}} \quad (79)$$

where,

δ : angle used in measuring out-of-roundness of spheres (radian)

The distribution of the measuring points is shown in **Fig. 1.8**. Two measurements are to be made at each point: one in the plane of the central axis, the other at right angles to it.

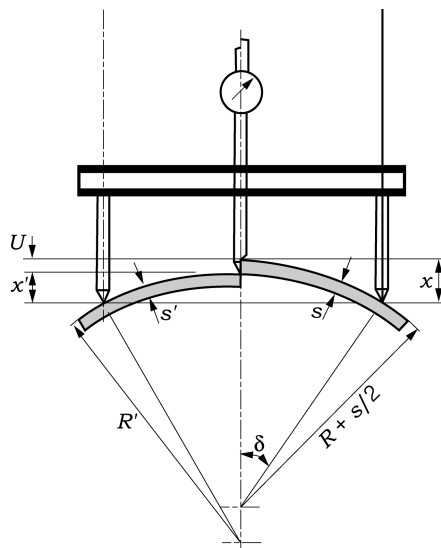

Fig 1.7

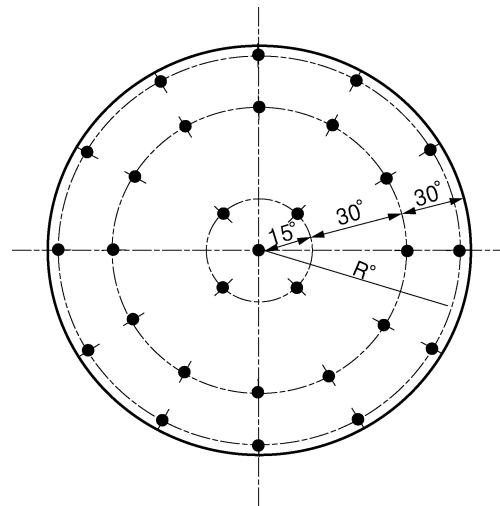

Fig 1.8

8.4 Calculation of permissible pressure for spheres with an out-of-roundness $u > 0.04 \cdot s/R$

The reduced permissible pressure P' calculated with formula (80) allowing for the actual radius of curvature R' and the minimum wall thickness occurring in the measuring range y (taking account of any reductions for wear and corrosion). The radius of curvature R' is determined with formula (81)

$$P' = P \left(\frac{R + \frac{s}{2}}{R'} \right)^2 \left(\frac{s'}{s} \right)^2 \leq P \quad (80)$$

$$R' = \frac{x'}{2} + \frac{y^2}{8x'} \quad (81)$$

9. Tolerance of Ring Stiffeners

A check is to be carried out on ring stiffeners to determine whether the following tolerances have been maintained.

- (1) Girth width (on T-section flanges, the whole width); $-0 \sim +5$ mm
- (2) Girth and web thickness ; $-0 \sim +1$

The tolerance t depends on the conditions of supply for the material. (If the material supply specification allows negative tolerances, these are to be allowed for in the calculations)

- (3) Height of ring (in the case of built-up profiles the height of the entire ring); $-2\% \sim +5\%$ of the total height
- (4) Unevenness of web and girth (measured over height of web and girth respectively): $0 \sim 1\%$ of web and girth height respectively
- (5) Symmetry of flange in relation to web (applicable to I- and T-section stiffeners; the difference from the edge of the girth to the web on both sides of the web); $0 \sim 4$ mm difference.
- (6) L_1 distances (distances between "light" stiffeners and separating "light" from "heavy" stiffeners); $-5.0 \sim +5.0$ mm
- (7) L_2 distances (distances between "heavy" stiffeners or ends separating "heavy" stiffeners from ends); $-15.0 \sim +5.0$ mm
- (8) Angularity of web in relation to wall or main axis : $-2^\circ \sim +2^\circ$
- (9) Angularity of flange in relation to web : $-3^\circ \sim +3^\circ$

All dimensional deviations are to be measured eight times on each stiffener at points equally spaced round the circumference. If the aforementioned tolerances are exceeded, corrective machining and/or manual work is to be carried out on the stiffener and/or the calculation is to be repeated with corrected dimensions. ↓

Annex 2 Design and Construction for Submersible with GRP

1. Design principles of the submersible with GRP

Upon manufacturing process, besides the appropriate materials approved, it shall be considered for the product characteristics and the special action is to be taken about the most important components to be effected.

For preparation, manufacturing and storing of reinforcing media and a resin compound to be reacted, it shall be verified for the manufacturing factory of materials or the other requirements recognized.

2. Workshops

The Submersibles with GRP shall be constructed at the workshops which is accepted by this Society. The workshop shall be in accordance with the latest process, quality control and certification, heat treatments, machine cutting, machine equipment to moulding, and maintained by an expert completing a proper training.

3. Requirements to workplace

3.1 General

- (1) The place to product and store shall be provided with an appropriate construction and the environmental requirements, and it is to be separated from the other workplace or other material storages in order to prevent them from contaminating.
- (2) The workplace and equipments shall be kept to maintain and clear so as to do the work effectively, and it shall surely be isolated from what are unnecessary equipments, other materials, the remains of reinforced fiber, the remained glasswool after construction.

3.2 Workplace of moulding

- (1) Hand lay-up process shall be carried out at the place where the room temperature is always to be 16°C or above, and when laminating and curing, the temperature of the moulding workplace is always to be 25 or above. If it is deemed by the surveyor as appropriate according to the requirements of work, it is acceptable to 0~2°C of allowance for the temperature.
- (2) When other method is used for moulding, the working temperature of the place shall be determined by independently consulting with the Society.
- (3) The humidity of the moulding workplace, as far as practicable, shall be the lowest, and then generally is to be 70 % or less. And it shall not be accepted that on moulding or materials there is the humidity changes to give rise to possibility of the moisture.
- (4) The monitoring apparatus shall be provided to monitor the humidity and the temperature in the workplace, and be measured and recorded continuously them. And they shall be recalibrated at least biennially by the authorized organization recognized by the Society.
- (5) The ventilation shall be made for a resin monomer not to dry too much, and it shall be able to discharge through the air vent.
- (6) The lighting of workplace shall be provided appropriately. and the resin hardness shall be carried out at the place not to be exposed directly by sunlight or a direct artificial light.
- (7) When there is a machine arising a dust, it shall not operate until completing the lay-up process or the bonding. And in general these equipments shall be required to install at the place separated.

3.3 Storing place

- (1) The resin liquids, according to the working requirements of the maker, shall be kept at the place to be ventilated and dried very well at 10~20°C. And when the resins are stored outside the workplace of moulding, in the workplace they shall be complied with the work temperature before working.
- (2) Hardeners and accelerators, according to the working requirements of the maker, shall be stored at the place to be ventilated and cleared very well. Pillars and bondings shall be stored in the enclosed bottles so that a dust or a humidity is not permeated. And the hardeners, according to the working requirements of the maker, shall be stored at the place to be free of a dust and

dry.

- (3) When the glass materials is stored outside the cutting workplace, in the workplace they shall be complied with the work temperature before working.

3.4 Handling of Materials

- (1) The entering and handling of materials shall be ensured that the materials are not contaminated or fallen off in quality, and always confirmed appropriately. The materials, anywhere, always shall be used according to the procedure, and when there is not the pre-consultation between the maker and the Society, the materials expired in using date shall not be used.
- (2) All auxiliary materials or remained ones, after delivery, shall be stored at the cumulated place or the previous storage one.

4. Manufacturing Process

4.1 Moulding

- (1) The moulding shall be made of a proper materials and the moulding is to be kept for the entire shapes and the elaborateness.
- (2) The materials used for moulding shall not give rise to the resin hardness
- (3) In the workplace to be accessible easily, the proper moving equipments shall be arranged inside or outside the workplace.

4.2 Laminating

- (1) The bolts shall generally be clear and dry, and before handling by a proper separating system, they are to be complied with the temperature condition of the ship. The release agents shall not restrain the function of gelcoats.
- (2) The gelcoats of 0.4 ~ 0.6 mm in thickness shall be painted by spray lay-up apparatus or rollers or brushes to disperse evenly.
- (3) Before making the first layer of reinforcements, the gelcoats shall not be exposed exceeding the limited hours according to the working requirements of the makers. And the gelcoats shall be reiterated with light reinforcements, having not exceeding 450 g/m^2 in weight.
- (4) For the sandwich construction made on the pure moulding, it shall be reiterated with resin compounds or a lots of resin coats outside before painting.
- (5) All mouldings shall be made of layers of the reinforcements and having the approved method about the sequence and the direction of the working. And at each layer it is to be reinforced by the glass materials required.
- (6) At the accumulated material layer under wet-on-wet condition, it shall be taken for heats not to be come out.
- (7) The laminating shall be done according to the procedure within the limited hours. And for the moulding and the bonding of construction members it is also to be completed in hours permitted.
- (8) When stopping the laminating, at the first layer of the reinforcement having this last laminating, it shall be made of a piece of glass wool. And the reinforcement shall be arranged through the laminating to maintain the strength continuously.
- (9) The connections and the bonding shall be made of doubling with the glass reinforcements having 600 g/m^2 in weight and 25 mm in thickness. If it is impossible to cut mouldings, the cutting edge shall be appropriately doubled or be of the moulding strip.
- (10) When the laminating quality producted is found to be disorder, it may be required by this Society a proper test with same panels as the actual manufactured ones.
- (11) When a laminating other than hand lay-up is applied, before working it shall be approved by this Society and then a special test may be required.

4.3 Details

- (1) When the thickness of laminating is changed, it shall be gradually decreased or increased by the taper working. If it is changed from sandwich laminating to solid one, the thickness of cores shall gradually decreased with the ratio of one to two or more. In general the frame and the reinforced section, in order to laminate under not hardening yet, shall be made of layer by layer.

- (2) On the construction parts there shall not be a discontinuity and fastening points. And it is to be properly reinforced for unbalanced members such as the connection of openings and attachments, etc.
- (3) The assembles outside the moulding, while moulding, shall be mould to the adjacent construction or be connected to angles comprising of layer of reinforcements.
- (4) At the fastening laminates mechanically the strength of the connection parts shall be kept the balance. The fastening shall be of the metal of preventing from a corrosion and be fitted at the proper space/ place so that the design requirement is satisfied. The fastening is also of the washer plated type to be able to use at the both side, and be welded at the cutting end of laminates and fastening holes.
- (5) The back-pads or inserting-pads with their proper strength shall be made for bonding the accessories. And the surfaces of the pads are to be adequately protected from contaminating.
- (6) The sandwich laminating, when inserting the materials able to endure the design loads and the compression, shall be satisfied with the connection of bolting or accessories. The inserted parts are to be attached very well to the lay-up surface and the cores.

4.4 Fitting-out and Hardening

- (1) Upon lay-up process, the moulding, while hardening, shall be remained until removing the resin. The hardening is to be kept for the required period by the makers or 12 hours or more. And then it may be changed for the moulding's density and resin's type.
- (2) A large construction, during fitting-out and detaching the bolts, shall be supported and reinforced adequately.
- (3) The Moulding, while processing it, shall be stabilized for the required times from the makers or 24 hours or more before a special moulding process by the makers.

5. Materials

5.1 Unsaturated Polyester resin

- (1) The type of unsaturated polyester resin for use shall be harden without heat treatment process partially.
- (2) The laminating and gelcoats shall be able to be used at sea, and the friction resistance is to be in good order. And aging stability orthophthalic resins shall not be used for gelcoats outside.
- (3) Colorful matters and thixotropic agents shall be only used as additives to gelcoats.
- (4) The laminates and gelcoats shall be manufactured with casting property as follows,
Fractured seal for gelcoat resin : 2.5 %
Fractured seal for laminating : 2.0 %
Maximum absorbed water : 60 mg after 7 days
- (5) In addition to **4** above, the cast laminating resins shall be kept for the thermal deforming temperature at least 53°C.
- (6) The cast resins specified in **4** and **5**, before hardening for 16 hours at the temperature of 40°C or more, shall be kept for 24 hours at the temperature of 18°C or more, and by using a proper hardening apparatus it shall be tested with a specimen prepared.
- (7) The above laminating resins shall be satisfied with the mechanical properties specified in **5.7**. And before manufacturing, the relevant documents in evidence such as test data, etc. shall be submitted to this Society.

5.2 Accelerators and Hardeners

- (1) Accelerators shall be made of matters to give rise to polymerization of resins, and the materials of hardeners is to be of ones to raise the hardening rate of accelerated resins.
- (2) The quantities with types for accelerators and hardeners, for the purpose of using in particular, shall be complied with the requirements of the resin-makers, and without partially heat-treatments it is to be capable of hardening.

5.3 Color pigment

- (1) Pigment shall not have an effect on the final hardening.
- (2) Pigment may be added to the resins by the makers or moulding worker. When doing by the moulding worker, it shall be dispersed with compatible polyester resins.

- (3) For the thickness of colorful pigments, the additional quantities shall not be put into more than ones recommended from the makers and then in any cases not exceeding to 5% of total weights of resins.
- (4) Where the laminating resins are consisted of the internal surface of seawater tanks or fuel oil tanks, no a pigment shall be used.

5.4 Pillars

- (1) The using pillars shall not have an effect on the resin property.
- (2) The kinds and amounts of pillars for filling resins, shall not give rise to change the viscosity. And the using quantity shall not exceed to 13% of weights of using resins (including 3% of thixotropic pillars) or one required properly by makers, whichever is less.
- (3) Pillars shall not be used for laminate of construction in seawater tanks or fuel oil tanks.
- (4) Pillars shall be dispersed evenly with resin compounds.
- (5) A similar alkaline type or calcium carbonate of pillars shall not be used for noncombustible laminate

5.5 Noncombustible laminate

Where noncombustible materials are taken from additive compounds given in resin system, the kinds and amounts of the additive shall not give rise to change the mechanical property or the resin's viscosity, and complying with the related requirements of the makes.

5.6 Fiberglass Reinforcements

- (1) Fiberglass reinforcements shall be made of "E" glass of silicic acid in low alkaline having 1% or less of Na_2O of the alkalic contents.
- (2) Fiberglass reinforcements shall be of the kinds and grades, and consisted of the followings.
 - (A) Chopped strand or continuous filament mat
 - (B) Fiber roving
 - (C) Single direction roving
 - (D) Fiber textile
 - (E) Compound reinforcements
- (3) The materials shall be ensured so sufficiently that there is no defects, discolorations, another substances and other flaws, and then having not an effect on the quality of laminate produced.
- (4) When the reinforcements are moulding to the laminate, it shall be kept for the mechanical property given in 5.7 (2), and then the makers are to be required to submit to the Society the data about this mechanical property before manufacturing.

5.7 Material properties of laminate

- (1) For laminate made of non saturated polyester resins or Fiberglass reinforcements, the mechanical property may be taken differently in accordance with the material's condition, constructing method and actual materials in use during manufacturing. While constructing the ship, if esteemed to choose resins, it shall be considered for the heat torsion of laminating resins and the fracture of laminating resins and gelcoats.
- (2) The reinforcements and laminate made of resins shall be composed of at least 30% of glass and the mechanical characteristic shall be not less than the following requirements.

(A) Final tensile strength	85 N/mm ²
(B) Modulus of tensile	6350 N/mm ²
(C) Final ductility strength	152 N/mm ²
(D) Modulus of ductility	5206 N/mm ²
(E) Final compression strength	117 N/mm ²
(F) Modulus of compression	6000 N/mm ²
(G) Final shear force strength	62 N/mm ²
(H) Modulus of shear force	2750 N/mm ²
(I) Shear force strength of internal laminate	17.25 N/mm ²
- (3) When the laminate contains something other than 30% of glass reinforcements, the mechanical property shall be esteemed to comply with the following formulas.

- (A) Final tensile strength $1278 G_c^2 - 510 G_c + 123$ (N/mm²)
 (B) Modulus of tensile $(37 G_c - 457) \times 10^3$ (N/mm²)
 (C) Final ductility strength $502 G_c^2 - 106.8$ (N/mm²)
 (D) Modulus of ductility $(33.4 G_c^2 + 2.2) \times 10^3$ (N/mm²)
 (E) Final compression strength $150 G_c + 72$ (N/mm²)
 (F) Modulus of compression $(40 G_c - 6.0) \times 10^3$ (N/mm²)
 (G) Final shear force strength $80 G_c - 38$ (N/mm²)
 (H) Modulus of shear force $(17 G_c - 2.24) \times 10^3$ (N/mm²)
 (I) Shear force strength of internal laminate $22.5 - 17.5 G$ (N/mm²)
- (4) For single direction roving, the tensile property shall be given in the following formula.
- (A) Final tensile strength $1900 G_c^2 - 1500 G_c + 560$ (N/mm²)
 (B) Modulus of tensile $(143 G_c^2 - 42.7) \times 10^3$ (N/mm²)

where

G_c : weights for glass contents of laminate according to the following formula.(except gel-coats)

$$G_c = \frac{2.56}{\frac{3072 T}{W} + 1.35}$$

T : nominal thickness of laminate determined by (4) (mm)

W : total weights for glass reinforcements of laminate (g/m²)

When single reinforcements herein is arranged to the direction of 0° or arbitrary or rectangular(0°, 90°), the minimum values shall be required.

- (5) When the specific gravity for glasses and resins are given between 2.56 and 1.2, the nominal thickness of laminate (except gelcoats) shall be summed up each laminate of reinforcements as the following formula.

$$t = \frac{w}{3072} \frac{2.56}{g_c} - 1.36 \quad (\text{mm})$$

where,

w : weights of reinforcement at one layer (g/m²)

g_c : contents of glass at one layer

- (6) Where glasses are contained very much in the resin reinforcements, the quantities shall not exceed to the following so that they are entirely permeated into the resins and become solid.

chopped strand mat or sprayed fiber	34 %
Fiber roving	50 %
Single direction roving	54 %
Fabric textile	50 %

- (7) The mechanical property of each resin used, as contents of glass, type, weight, nominal thickness, shall be stated on working drawing.
- (8) When the mechanical property of laminate used is different from the above (3), it shall be confirmed by testing to know whether it can be used or not. And then the specimen shall be sampled on the laminate that before hardening for 16 hours at the temperature of 40°C or more, shall be kept for 24 hours at the temperature of 20 ± 5°C.

When determining the ductile specification, the moulding surface shall be in tensile condition, and then all test methods and the sampling specimen shall be complied with the requirements

of **Annex I** for Guidance Relating to the Rules for Classification of Ships of Fiberglass Reinforced Plastics.

- (9) For compounded laminate, when the textile reinforcements is required to get internal shear force strength especially, it shall be taken more than the required value of laminate (refer to (3) above).
- (10) The specimen shall be sampled by the makers, and it is to be taken from the same as the materials to be used, and having same manufacturing specification, materials and a series of products.

5.8 Cores of Sandwich Construction

- (1) The reinforced plastics in stiffness shall be complied with the following requirements.
 - (A) A good safety in durability is to be taken and the enclosed hull type not to be permeated with oil, fuel and water.
 - (B) Lower water absorptiveness is to be taken.
 - (C) Coexistence with polyester resins is to be possible.
 - (D) A excellent strength is to be kept at 60°C of temperature.
 - (E) Mechanical property is to be taken not less than the value given in **Table 2.1**

Table 2.1 Mechanical property to cores of sandwich construction

Materials	Density (kg/m ³)	Strength (N/mm ³)			Elastic Modulus (N/mm ³)	
		Tensile	Compression	Shear force	Compression	Shear force
Polyuretane (PU)	96	0.85	0.60	0.50	17.2	8.5
Polyvinyl-chlorides(PVC)	60					

- (2) The end-grain balsa shall be complied with the following requirements.
 - (A) Action is to be taken against a fungus and insects.
 - (B) Disinfection is to be taken.
 - (C) 12 % of average humidity is to be maintained.
 - (D) Where small blocks is constructed with formative sheets, open-weave and bonding shall be coexistence and soluble in polyester laminate resins.
 - (E) Mechanical property is to be taken not less than the value given in **Table 2.2**

Table 2.2 Minimum mechanical property to End-grain balsa

Density (kg/m ³)	Strength (N/mm ³)				Shear force	Modulus of compression (N/mm ³)		Elastic modulus of shear force
	Compression		Tensile			Direction of stress		
	Direction of strength					parallel with grain	vertical with grain	
	parallel with grain	vertical with grain	parallel with grain	vertical with grain				
96	5.00	0.35	9.0	0.44	1.10	2.275	35.2	105

- (3) Other cores shall be esteemed to be used for those purpose and specification. And all test methods and sampling the specimen shall be complied with the requirements of **Annex I** for Guidance Relating to the Rules for Classification of Ships of Fiberglass Reinforced Plastics.

5.9 Materials of Consolidated construction members

The steel or aluminum alloy to be used for construction, shall be properly satisfied with the purpose to use. And components or members consisted of these materials shall be able to attach to lami-

rates and do not have an effect on hardness of resins. The surface of members facing with resins shall be wholly clear and cleared off alien substances. And as far as possible a shot blasting or one of surface treatment (e.g. abraded) shall be taken at the key equipped. ↓

Annex 3 Stability of Submersibles (2021)

1. General

1.1 Drawing and documents

This Annex shows the minimum requirements for drawings and documents described in **205. Sec.2, Ch.1, Part 1** of the Rules. After weight and inclination test, the Trim & stability report and Damage stability report should be submitted to the Society and located onboard always. The drawing and documents for the verification of stability should be included as following;

- general arrangement
- center of gravity and volume/capacity arrangement for all compartment and tanks
- lines plan
- hydrostatic curves.
- report of weight and inclining test
- trim and stability report
- damage stability report

1.2 Definition

- (1) Surfaced displacement, Δ_f , is the same as the displacement of common surfaced ships. For submersibles, the surface displacement is based on fully boarded crews and passengers or cargo, 50% of filling in trim tanks which controls longitudinal trim, full consumable items, empty compensating tanks and empty diving tanks.
- (2) Submerged displacement, Δ_b , is resulted from adding a volume of diving tanks to surfaced displacement. Sea water in free flooded zones is not included to this displacement.
- (3) Free flooded zone as a part of hull compartments is admitted free inflow and ventilating of sea water.
- (4) Diving tanks known as soft ballast are ballast tanks to increase weight for diving. The capacity of diving tanks is to be designed to acquire the equilibrium of buoyancy and weight, known as neutral buoyancy, in submerged condition (refer to **Fig. 1**).

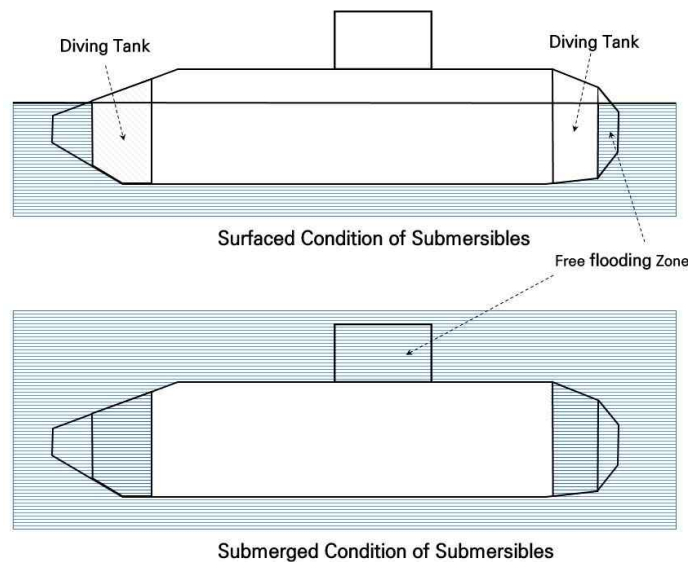

Fig.1 Diving tanks in surface and submerged condition

- (5) Compensating tanks known as hard ballast are ballast tanks to increase or decrease weight for obtaining the equilibrium of buoyancy and weight when decrease of pressure hull volume due to external pressure or decrease of weight due to consumption of fuel and stocks in submerged condition.

- (6) Permanent ballast is a kind of fixed ballast in order to obtain the equilibrium of buoyancy and weight. For the case of lack of weight, permanent ballast using heavy material is to be attached to hull bottom. This ballast can be removable for emergency surfacing. For the case of lack of buoyancy, syntactic foam (reinforced glass foam) can be installed to hull in order to get sufficient buoyancy and is to be checked strength to endure the external pressure in the maximum target depth.
- (7) Freeboard of submersibles is vertical distance from waterline to freeboard deck which means the uppermost deck of compartment to provide the reserve of buoyancy.
- (8) Reserve of buoyancy (ROB) means the volume of enclosed space above waterline. The size of ROB is to be designed to retain the sufficient height of freeboard to secure safety of loading/unloading and works on freeboard deck. Also, this ROB is main parameter to decide the capacity of diving tanks (refer to **Fig. 2**).
- (9) Angle of down flooding, θ_f , is a heeling angle when flooding is starting at the whether-tight opening, with unavailable closing rapidly, installed superstructure, deck or hull.

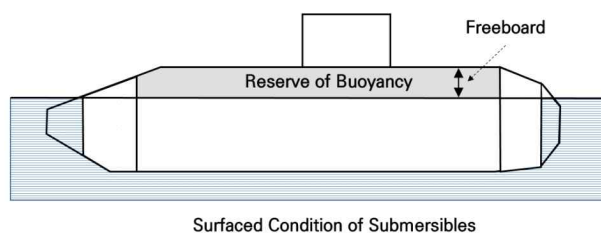

Fig. 2 Reserve of buoyancy and freeboard

2. Weighting and Inclining Test

2.1 Weighting test

- (1) If weighting buoy is used, the buoy, connected vertically on the center of buoyancy of submersibles by cable, should have draught mark corresponding to traction force in submerged condition. Weighting test is to be performed at equilibrium of weight and buoyancy in submerged condition with zero velocity, zero heeling and trimming based on including all variable weights, which are crew, passenger, consumable weights, liquid in pipe and tanks. The weighting test depth is generally less than 30 m as it can be ignorable the volume shrinking of pressure hull due to external pressure.
- (2) The other method for weighting test can be applied under the Society approval when applicable.
- (3) Before weighting test, the location of each weight in way of longitudinal, transverse and vertical direction is to be reported in order to rearrange for inclining test.

2.2 Inclining test

- (1) Generally, the inclining test is to verify LCG, VCG, surfaced and submerged displacement through measuring angle of heeling and trimming after moving of experimental weight in each way of longitudinal and transverse direction.
- (2) The test should be performed at protected calm area where is not influencing by the effect of wind and stream.
- (3) The specific gravity of water should be measured based on the samples collected from sufficient depth of test site including near surface and be corrected considering temperature of water at the same time if the site has not the certified specific gravity.
- (4) The trim of submersibles is to be less than 0.1° and the number of tanks filled with liquid should be minimized if possible. The free surface effect of tanks is to be considered precisely while test is progressing (refer to **3.3**). The capacity and weight of all liquid tanks and compartments are to be checked and recorded. Especially, the bilge tank should be empty and rested air pocket in trimming and air pipes should be emptied.
- (5) The experimental weight for inclining must be sufficient to heel and trim $1 \sim 3$ degree of angle in way of vessel's longitudinal and transverse direction. If not available to use solid weight, liquid transference between two symmetric tanks located for each direction may be substituted under approval of the Society.
- (6) Several certificated clinometer or pendulums are to be used for correcting the error of measurement.

- (7) For verifying submerged displacement, diving tanks are to be fully filled and compensating tanks are to be partially filled to ensure staying in submerged condition with neutral buoyancy. Submerged inclining test must carry out under the condition below Sea-state 2.
- (8) For verifying surfaced displacement, the draught data measured from starboard and port sides at amid ship, stern and bow should be averaged. Especially, the capacity of unventilated water in diving tanks is to be reported. Also, all bilge and decks should be dried.
- (9) If the change of weight is occurred due to maintenance or conversion, weighting and inclining test should be carried out again in case that the change of weight can not be controlled by the weight compensation tank and affect to stability.

3. Intact stability

3.1 Submerged intact stability

- (1) Heeling in submerged condition does not induce volumetric change and move the center of buoyancy of submersibles. Also, the location of metacenter is the same as center of buoyancy because water plane is not exist. As shown in below formulas, the height of metacenter, \overline{GM} , is the same as \overline{GB} (refer to **Fig. 3**). In below formula, I means 2nd area moment of water plane and ∇ is volume of displacement. The center of gravity is always to be below the center of buoyancy in order to maintain stable state in submerged condition.

$$\overline{KM} = \overline{KB} + \frac{I}{\nabla} = \overline{KB} + \frac{0}{\nabla} = \overline{KB}$$

$$\overline{GM} = \overline{KM} - \overline{KG} = \overline{KB} - \overline{KG} = \overline{GB}$$

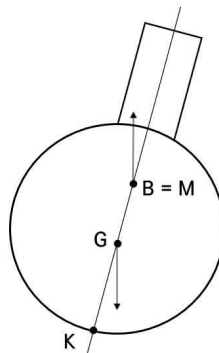

Fig. 3 GB in submerged condition

- (2) For all loading cases in submerged condition, \overline{GB} is to be not less than the greater of 0.05 m or as following value (refer to **Fig. 4**);

$$\overline{G^1B} = \overline{GB} \tan \alpha$$

$$\overline{GB} \geq \frac{w d}{\Delta \tan \alpha}$$

where;

- w : moveable weight, in ton, generally 10% of total weight of boardable passengers (73kg/passenger) or cargo,
- d : maximum transformable distance, in mm, in way of longitudinal direction in pressure hull for moveable weight,
- Δ : total weight, in ton, of submerged displacement with subtraction of water weight in diving tanks,
- α : maximum allowable trimming angle for normal operation of equipments installed in pressure hull, not greater than 25°.

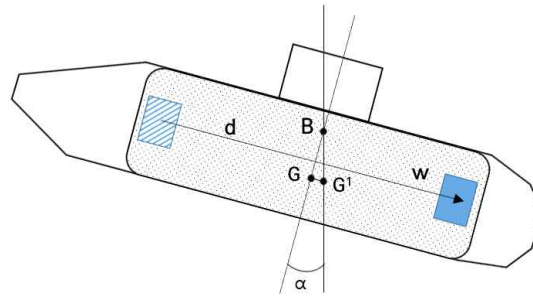

Fig. 4 Limitation of trimming angle due to moveable weight

3.2 Surfaced intact stability

- (1) The stability of submersibles in surfaced condition is based on \overline{GM} in the same manner of surfaced ships. When submersibles is heeling on the surface, the center of buoyancy is moved to new location and the metacenter above center of gravity raises the righting moment (refer to Fig. 5).

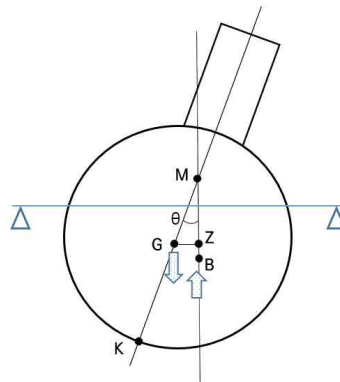

Fig. 5 GM in surfaced condition

- (2) The bow configuration of submersibles is very different from that of surfaced ships. The change of trim angle due to weight distribution in surfaced condition leads to rapid decreasing of water plane area. The longitudinal transformation of center of gravity should be minimized in surfaced condition (refer to Fig. 6).

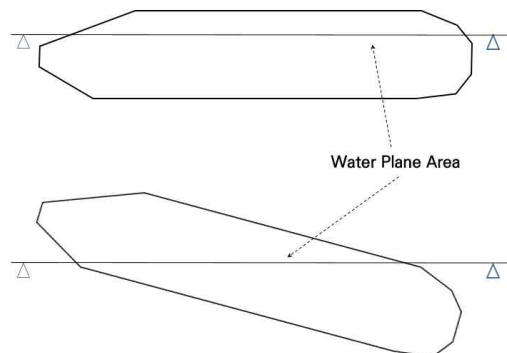

Fig. 6 The change of water plane area due to trimming

- (3) The righting moment arm curve is to be provided from 0° to the angle which is lesser of 90° , angle of down flooding, θ_f or capsizing angle, θ_c for verification of intact stability. The maximum righting moment arm, \overline{GZ}_{MAX} , is to be calculated at not less than 60° of heeling angle. θ_s corresponding to \overline{GZ}_{MAX} means the limitation of static stability and maximum righting moment. \overline{GM} is to be always greater than 0.1m. The intact stability for submersibles should satisfy $A_{30} \geq 0.027 \text{ m-rad}$ and $A_{45} \geq 0.034 \text{ m-rad}$ as shown in Fig. 7.

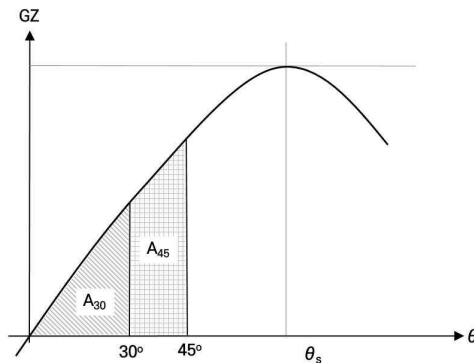

Fig 7. Requirements of intact stability at surfaced condition

- (4) The effect of wind in way of transverse direction should be considered at the surfaced condition. The heeling moment arm, in m, due to wind is following;

$$H = \frac{0.0195 V^2 A h \cos^2 \theta}{1000 \Delta_f}$$

where;

V : wind speed, in knots, applied as 100 knots for North Atlantic sea and 80 knots for other areas. If the operation of submersibles is governed by environmental condition, the wind speed under 80 knots may be allowed to apply based on the Society approval.

h : vertical distance, in m, from the center of side projection area below waterline to the center of area exposed by wind pressure,

A : area, in m^2 , exposed by wind above water line,

θ : heeling angle, in radian,

Δ_f : surfaced displacement, in ton.

The intact stability against dynamic rolling due to wind should satisfy the requirements as shown in Fig. 8. When the total range of rolling is assumed as less than 30° based on 15° of heeling angle corresponding to static equilibrium, the area, A_R , is to be greater than 1.4 times of the area, A_H , and the heeling moment arm, H , is to be less than 60% of maximum righting moment arm.

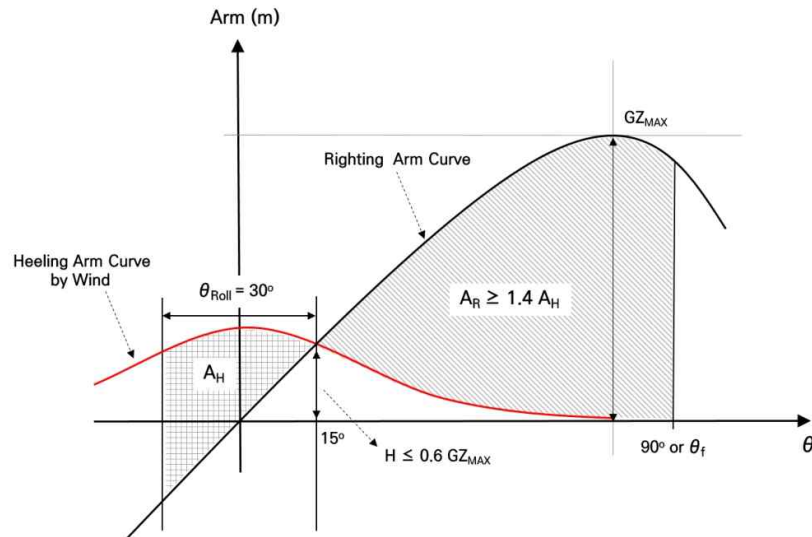

Fig. 8 Intact righting and heeling moment arm curve due to rolling by wind

- (5) The icing on the deck and superstructure during winter time can introduce the increment of displacement, change of trim and rise of center of gravity. The submersibles considering the effect of icing are to be satisfied the requirements described in (3) and (4). However, 70% of wind speed required from (4) can be applied. The increment of weight due to icing is 140kg/m^2 for horizontal area and 70kg/m^2 for sloping area.

3.3 Free surface effect

The verification of intact stability must include the free surface effect of liquid tanks in submersibles regardless of submerged or surfaced condition. This effect is to be reflected to correct initial \overline{GM} and righting moment arm curve for each heeling angle and each filling level of tanks considering the density of liquid. The free surface effect is to be considered in condition that the filling level is under 100%. The small tank with less than 100L is not applicable to free surface effect. When submersibles stay on the surface, the free surface effect for rest of water in diving tanks is to be included.

4. Damaged stability

4.1 General

- (1) When the damage is happened in submerged or surfaced state, the submersibles are to be surfacing immediately and stayed in surfaced condition. The damage stability is based on the assumption of staying in the surfaced condition.
- (2) The damage stability report is to be included as following;
 - based on the assumption of intact pressure hull for all damage conditions,
 - volume, center of gravity and permeability of ballast tanks,
 - location, closing and tightening type and operation method of opening installed at the bulkhead and deck,
 - detail bilge tank plan and accidental level,
 - calculation results of damage stability for all possible accidents.

4.2 Calculation of damaged stability

- (1) Final heeling and trimming angle are to be less than 15° and 10° each by each before starting the damage control. The damage righting moment arm curve is to be provided from 0° to the angle which is lesser of 60° , or angle of down flooding, θ_f . \overline{GM} corrected by considering free surface effect is to be greater than 0.0 m. The damage stability for submersibles should satisfy $A_{45} \geq 0.019 \text{ m-rad}$ and $A_{60} \geq 0.023 \text{ m-rad}$ as shown in Fig. 9.

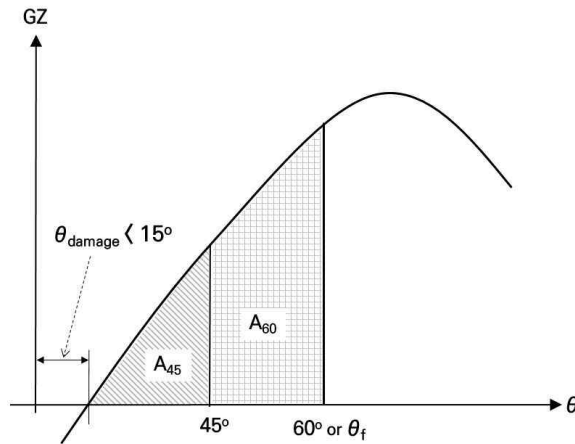

Fig. 9 Damage righting moment arm curve of submersibles

- (2) The damage stability against dynamic rolling due to wind should satisfy the requirements as shown in Fig. 10. When the total range of rolling is assumed as less than 30° from the 22.5° of heeling angle corresponding static equilibrium, the area, A_R , is to be greater than 1.4 times of the area, A_H . ↓

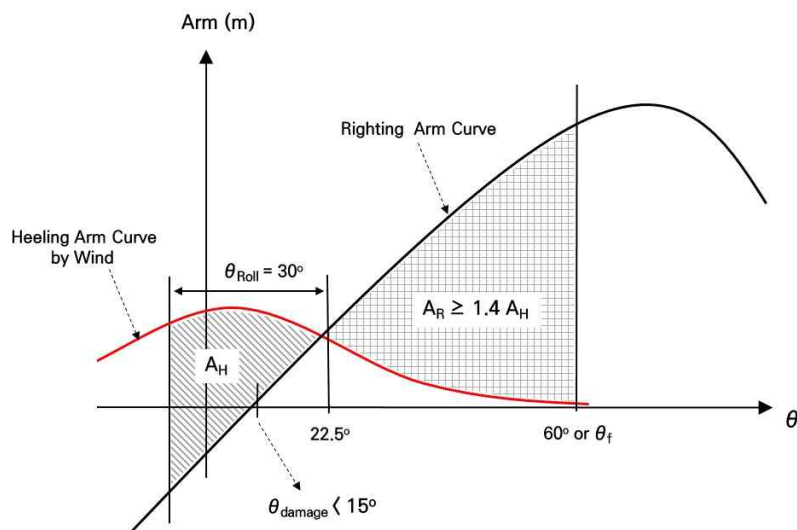

Fig. 10 Damage righting and heeling moemnt arm curve due to rolling by wind

**RULES AND GUIDANCE FOR CLASSIFICATION
OF UNDERWATER VEHICLES**

Published by

KR

36, Myeongji ocean city 9-ro, Gangseo-gu,
BUSAN, KOREA

TEL : +82 70 8799 7114

FAX : +82 70 8799 8999

Website : <http://www.krs.co.kr>

Copyright© 2021, **KR**

Reproduction of this Rules and Guidance in whole or in
parts is prohibited without permission of the publisher.